

JAMS

Certification by Analysis I and II

Gerardo Olivares

May 20th 2010



WICHITA STATE
UNIVERSITY



The Joint Advanced Materials and Structures Center of Excellence

- **Phase I: HII and HIII FAA Numerical ATD Validation**
[July 2005 - July 2010]:
 - Test variability HII and HIII FAA ATD with 2,3, and 4-point restraints.
 - Numerical ATD V&V Procedure.
 - Comparison HII and HIII FAA dynamic performance.
 - SAE ARP 5765 ATD reference data.
- **Phase II: Seat Structural Modeling Techniques**
[September 2006 - September 2010]:
 - Seat Structure: Material models, joint definitions, and modeling techniques using FE and MB approaches.
 - Component Level Tests Protocols: Seat Cushion, Seatbelt Webbing.
 - Pitch and Roll Modeling Procedures.
 - Numerical model application, documentation and validation per AC 20-146

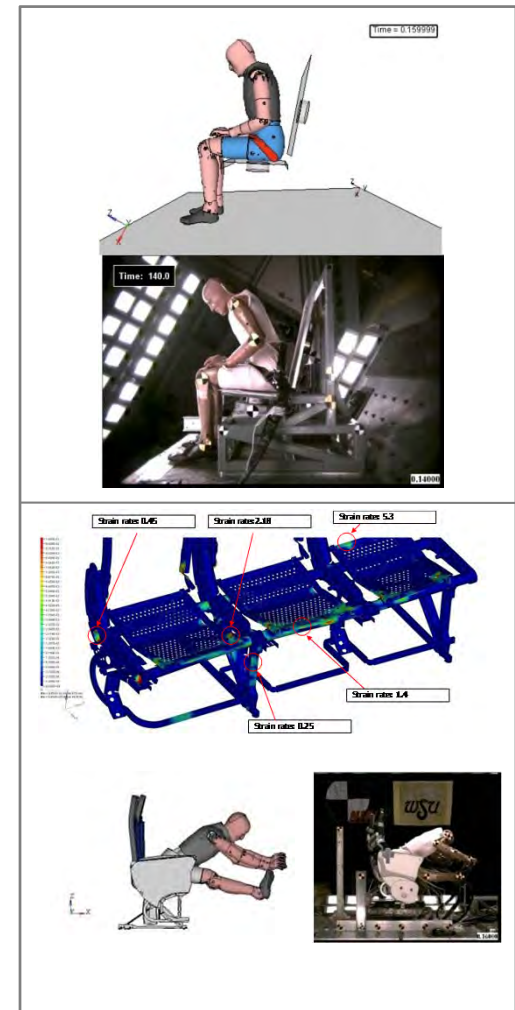

CBA II Research Program Overview

- **Phase I: Airframe Crashworthiness Evaluation*** by Analysis [July 2009 –September 2010]:
 - Evaluation coupon level material testing variability – Composites (Fiberglass, Toray-Carbon Uni, Toray Carbon Fabric) and Metallic Materials (Al 7075-T6)
 - Coupon Level Material Model Validation – Composites and Metallic Materials
 - Literature review NTSB aircraft crash data
 - Develop an energy based analytical method to define stiffness, crush zone, and deceleration profiles
 - Metallic airframe preliminary crashworthiness evaluation – Hard Surfaces, Soft Soil and Water Impact
 - Propose Airframe Crashworthiness Evaluation Methodology
- * Note there are no current requirements for airframe crashworthiness, only special conditions with the introduction of composite fuselages (equivalent level of safety to metallic structures).

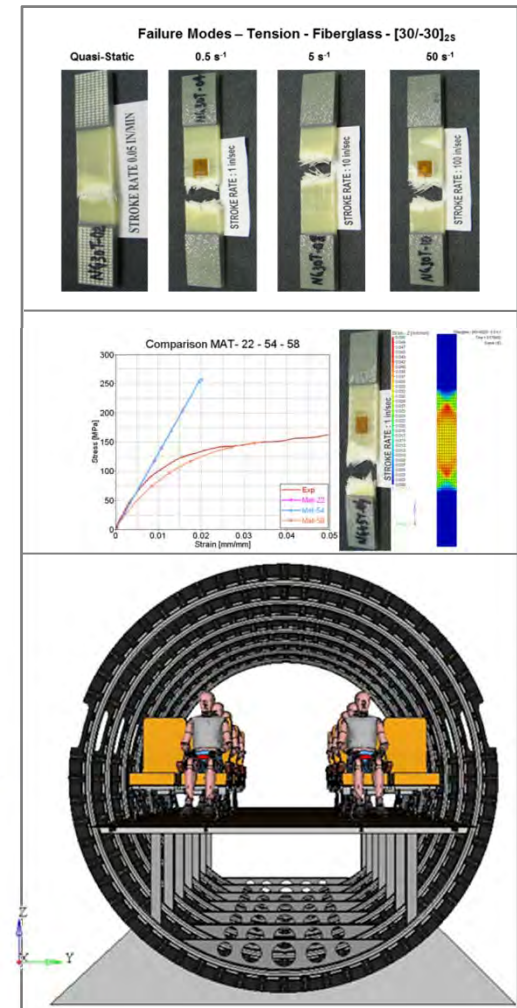

FAA Sponsored Project Information

- Principal Investigators & Researchers
 - G.Olivares PhD, PI.
 - CBA I :V. Yadav, N. Dohle
 - CBA II: J. Acosta, S. Keshavanarayana PhD (Material Characterization)
- FAA Technical Monitor
 - Allan Abramowitz.
- Other FAA Personnel Involved
 - Rick Dewesse (CAMI).
 - David Moorcroft (CAMI).
- Industry Participation [CBA I]
 - Weber Aircraft, Contour Seating ,B/E Aerospace, SICMA, IPECO, Recaro, Schroth Safety Products, AMSAFE, TASS/TNO-MADYMO, Altair-Radioss, FTSS, ESI-Pamcrash, MSC, Cessna, Airbus NA, Hawker/Beechcraft, Gulfstream, SAE Seat Committee.

Certification by Analysis I – Phase I

– Phase I: Numerical Anthropometric Test Dummies:

- Literature review and numerical tools survey.
- Sled testing – Rigid Seat (Series I [23 Sled Test] and II [30 Sled Tests]).
 - Test variability studies – Establish corridors for validation criteria.
 - ATD Validation reference database.
- Validation criteria:
 - Validation metrics methods: review and evaluation.
 - Identify data channels required, and tolerance levels for model validation.
- Simulation studies:
 - Survey numerical ATD databases availability.
 - Preliminary evaluation of numerical ATDs with sled test data for part 23.562 and 25.562 dynamic requirements.
- Comparison HII vs. HIII FAA ATD performance.

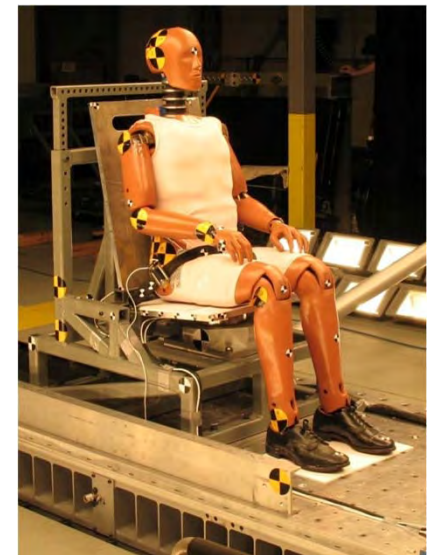

- vATD evaluation completed / data submitted to SAE working group
- Reference Sled Tests completed, submitted to numerical ATD developers and SAE ARP 5765 working group. - July 09 ✓
- Develop testing protocols and data requirements to validate computer models. - July 09 ✓
- HII and HIII FAA test repeatability studies completed ([2, 3 and 4 point restraints] [0 and 60 deg Test Conditions] [Dynamic conditions FAR 23.562 and 25.562]). ✓
- CBA Phase I final report Volume I submitted in April 2010. ✓
- Comparison study of HII and HIII FAA performance for typical aerospace applications.[2, 3 and 4 point restraints] [0 and 60 deg Test Conditions] [Dynamic conditions FAR 23.562 and 25.562]. ✓
- Ongoing reports: CBA I Volume II ATD Reference Test and Validation Methodology CBA Volume III Seat Modeling Techniques and Validation ,Comparison Study of the HII and HIII FAA ATDs under FAR 23.562 and 25.562 Dynamic Test Conditions.
- Technology Transfer:
 - Participation SAE Seat Committee.
 - Validation metrics, criteria, and test database submitted to SAE ARP 5765 WG. ✓
 - Support development and validation efforts of numerical models. ✓
 - HII and/or HIII FAA ATD Finite Element and Multibody numerical models are available from FTSS, MADYMO, Pamcrash, and Radioss. ✓
 - Four technical reports (Ongoing)

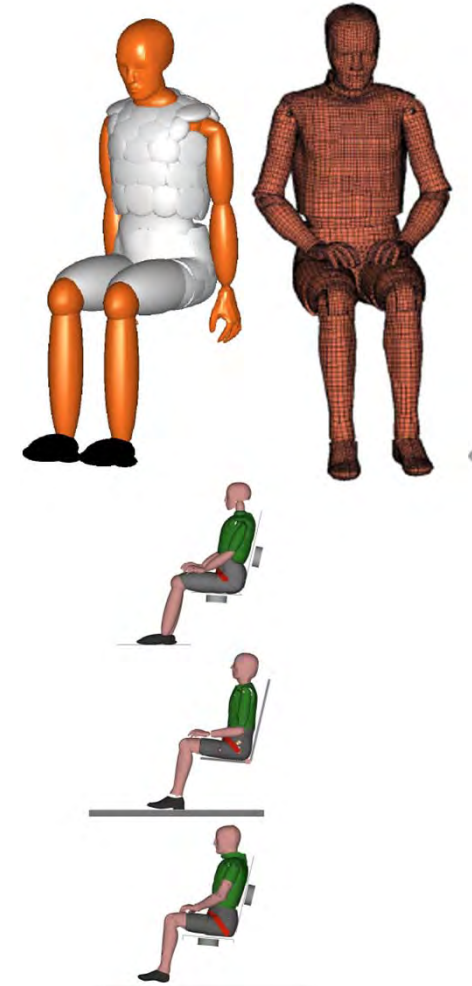

Certification by Analysis I – Phase II

– **Phase II: Aerospace Seat Material Modeling Requirements and Component Testing Protocols:**

- Literature review: material data, testing protocols.
- Survey of materials used in aerospace seating applications.
- Review of material data required for numerical analysis:
 - Material Models: Structural components, cushions, and webbing.
 - Strain rate definition for typical structural components.
- Seat modeling techniques
- Analytical FE Studies for various aerospace seat configurations:
 - Two and three passenger coach class seats (Part 25).
 - One first class seat (Part 25).
 - Six business jet seats (Part 23 and 25).
 - Two side facing seat (Part 25).
- Experimental Studies for various aerospace seat configurations.
 - Strain and strain rate measurements.
 - Comparison studies with analytical solutions.
- Component Testing Protocols: Metallic components, seat cushions, and belt webbing.

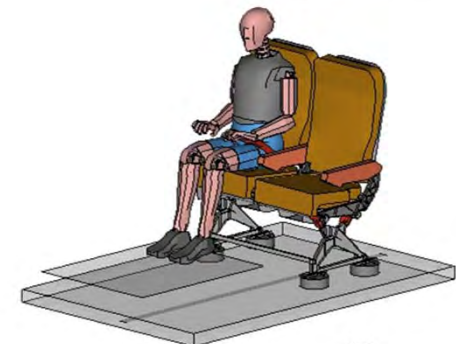
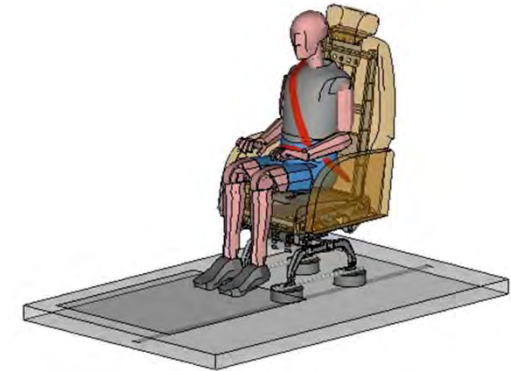

JAMS Seat Modeling Process - CAE

3D CAD MODEL

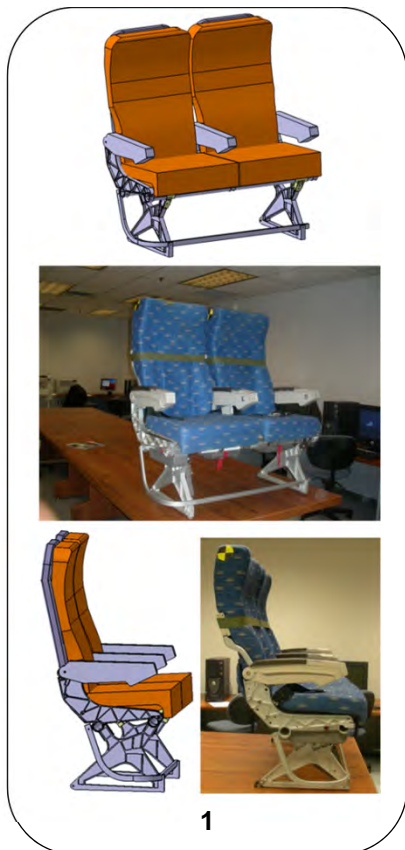

GEOMETRY DEFEATURE

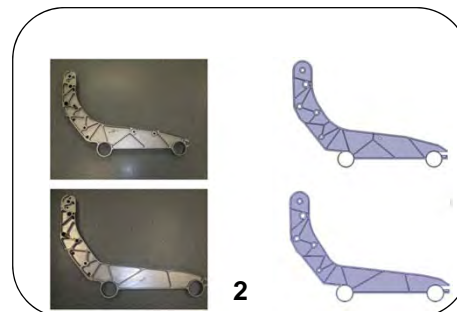

GEOMETRY DISCRETIZATION

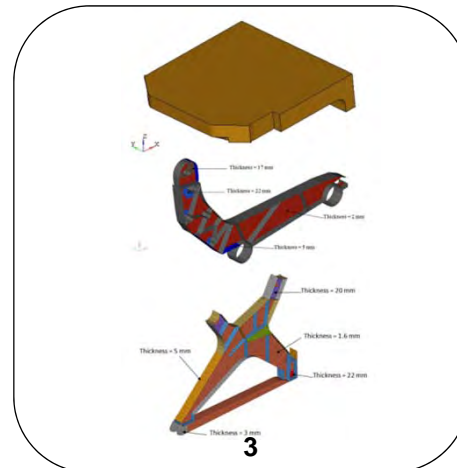

NUMERICAL MODEL DEFINITION



EIGENVALUE ASSEMBLY CHECK

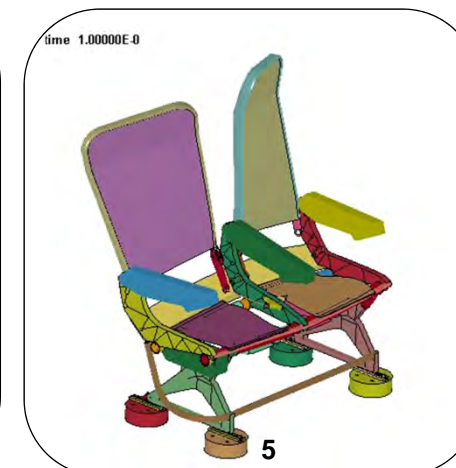

OCCUPANT & BELT POSITION

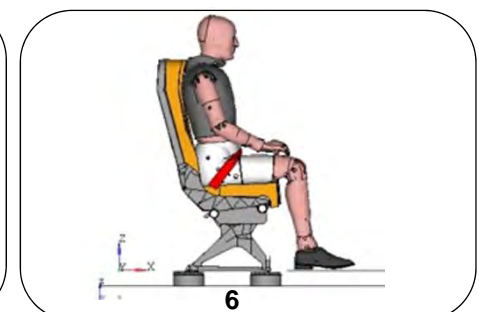

DYNAMIC EVALUATION



Component Level: Structural Components Material Definition

Recommended Procedure:

- Prepare initial model with quasi-static MMPDS-01 material data.
- Conduct a dynamic simulation with quasi-static material data to identify areas with plastic deformations, and the strain rate magnitudes for these components.
- For most seat structural members, quasi-static data from MMPDS-01 may be used to define material properties.
- For typical coach type seats, part 25.562 testing applications quasi-static material data can provide acceptable results (0.1 to 7/s). For heavier seat structures (first class and business jet seats under FAR 25.562 or 23.562 test conditions) certain structural components may have to be defined with strain rate dependent data (0.1 to 15/s).
- Industry/FAA needs to define a standard high strain rate testing protocol to develop mechanical properties .

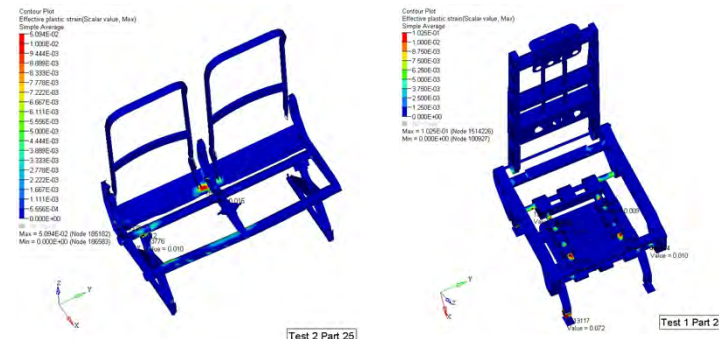
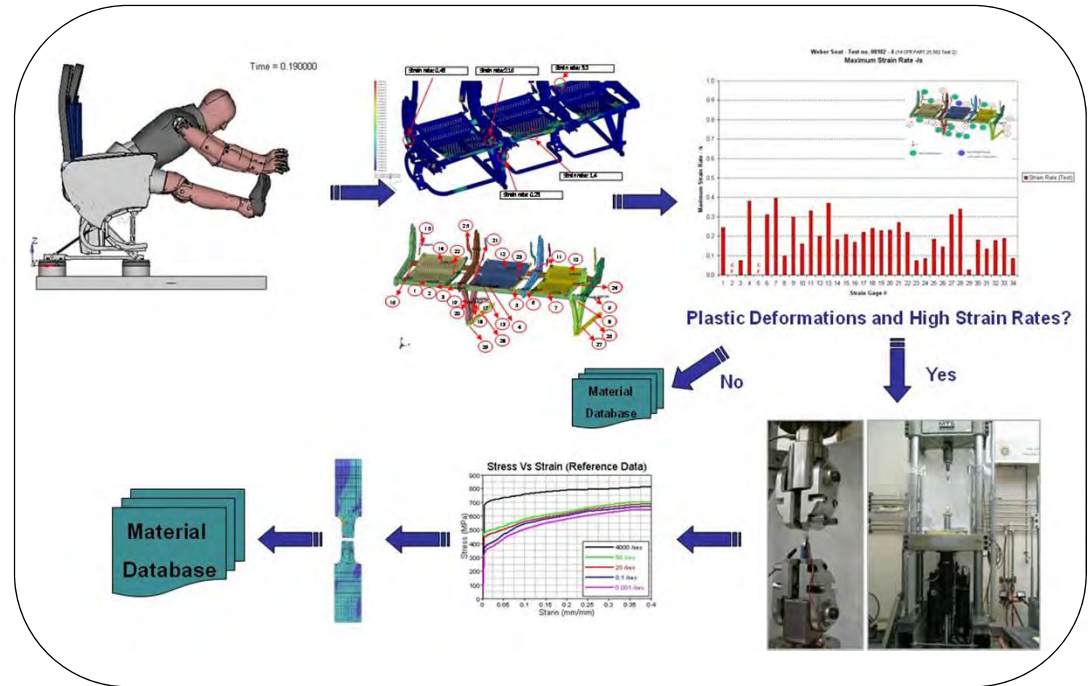

Component Level: Seat Belt Webbing

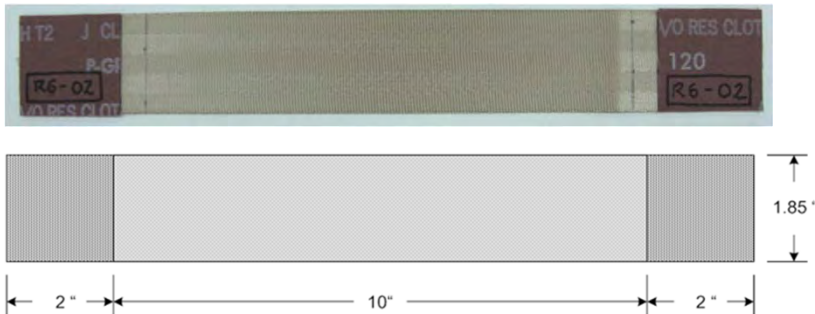

Recommended Test Protocol:

- Three test samples
- Gage Length: 10 in / Tab Length: 2 in
- Tab – abrasive sanding cloth 120 Grit
- Servo-hydraulic load frame with a 55 kip piezoresistive load cell
- Procedure:
 - Apply grip pressure (3,000 lbs)
 - Verify alignment of the belt with gripping wedges
 - Introduce pre-load (20 lbs) to correct for initial slack
 - Defined a loading and unloading profile (0 lbs to 2600 lbs to 0 lbs)

ID	Rate [in/min]	P_{max} [lbf]	Elongation [%]
AS-W1200-R6-01	6	2531.96	7.470
AS-W1200-R6-02	6	2529.73	7.409
AS-W1200-R6-03	6	2530.05	7.377

AVERAGE	2530.582	7.418
STANDARD DEVIATION	1.207	0.047
CO-EFFICIENT OF VARIATION [%]	0.048	0.640

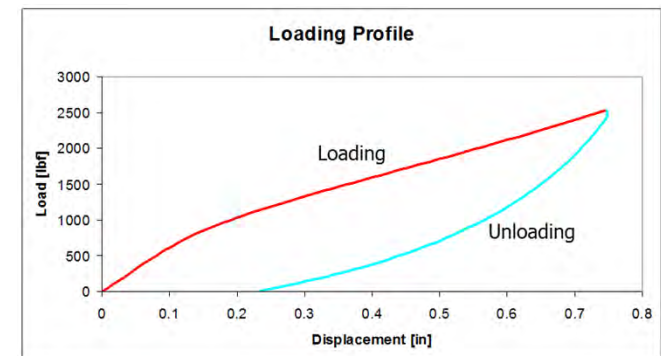

Component Level: Seat Cushion



Piezoresistive type load cell
 PCB Model 206 M33
 Platen
 Foot
 MTS hemispherical platen

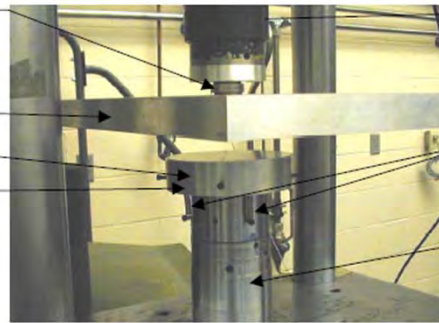

Springs
 Actuator

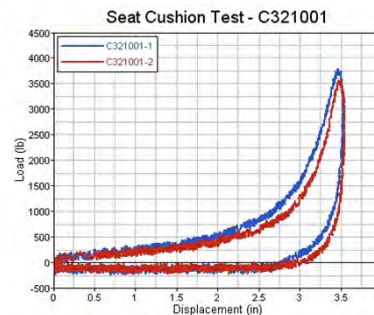
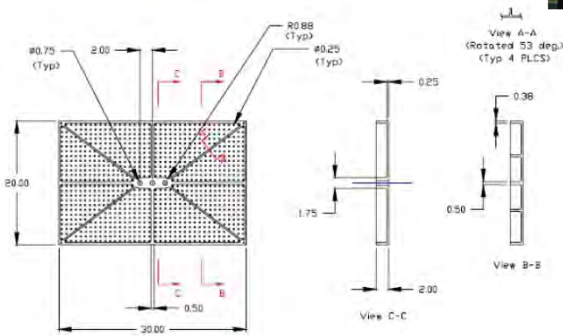
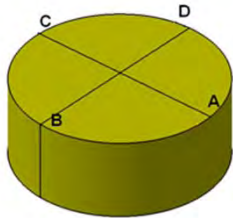

Recommended Test Protocol:

- Test protocol defined in DOT/FAA/AR-05/5 *Development and Validation of an Aircraft Seat Cushion Component Test*.
- The specimen shall consist of a 7 1/2-in. diameter cylinder. The upper and lower surfaces of the specimens are required to be parallel. The unloaded specimen thickness shall represent the unloaded cushion thickness at the position of the anthropomorphic test dummy (ATD) ischial tuberosity (BRP) when the dummy is placed in the seat.
- The specimen shall be loaded in compression, under displacement control, at a loading rate of approximately 27-33 in/sec to a maximum deflection corresponding to a $\Delta L/L$ of 0.9 (or the maximum value achievable without risking damage to the test stand and instrumentation).
- Validate material model and lumbar load predictions with dynamic tests.
- Note that for certain types of cushion cover materials the complete seat cushion with the cover should be tested.



Simulation in Support of Dynamic Testing per AC 20-146



Application of Computer Modeling in Support of Dynamic Testing: Purpose of identifying the most critical configuration/installation. A final certification test to the requirements of 14 CFR parts 23, 25, 27, or 29, §§ 23.562, 25.562, 27.562, or 29.562, will be required to certify this critical configuration/installation.

Determination of Worst-Case for a Seat Design: Upon completion of the computer analysis, the results from the simulation may be used to determine the worst-case or critical loading scenario for a particular seating system. This may include the following:

- Identifying components of seat structure that are critically loaded.
- The selection of the critical seat tracking positions (such as seat adjustment positions).
- An evaluation of the restraint system (such as critical attachment location).
- An evaluation of the yaw condition to address loading on the seat frame and movement of the occupant out of the restraint system.
- The number of seat places occupied.
- The selection of the worst-case seat cushion build-up.

Determination of Worst-Case Scenario for Seat Installation: Results of a validated computer model may be used to select the worst-case seat system installation as a candidate for dynamic testing. In determining the most critical seat installation, each seating system shall be analyzed in its production installation configuration.

Determination of Occupant Strike Envelope: The results of the computer analysis may be used to determine the occupant strike envelope with aircraft interior components. Each seating system should be analyzed in its production installation configuration. The occupant strike envelope will determine if a potential for head strike exists and, if so, which items are required in the test setup during the HIC evaluation tests.



Simulation in Lieu of Dynamic Testing per AC 20-146



Application of Computer Modeling in Lieu of Dynamic Testing There will be occasions when the applicant wishes to certify a seat that is based on a certificated design concept (a family seat design) but differs from the certificated design. When the applicant intends to use the results of computer modeling to provide engineering/certification data in lieu of dynamic testing for a modified design, the results from this validated model may be applied to the following modifications:

- **Seat System Modification:** Analysis based on a validated computer simulation may be used to substantiate seat designs or installations that have been modified from a certificated configuration. These modifications may include changes to primary and non-primary load path structural members.
- **Seat Installation Modification:** Analysis based on a validated computer simulation may be used to substantiate configuration changes to seat installations. The primary application is to show HIC compliance .

Applicability: This section is not applicable to changes to the seat-floor attachment structure. Significant changes to the material or mechanism of load transfer of the seat-to-floor attachments from the certificated baseline seat design (which includes the seat-to-track fitting and track substantiated under TSO-C127/127a), will require a new series of dynamic tests. Simple changes to the location of the seat-to-floor attachments are not included in this limitation, and they can usually be analyzed using static methods.

Validation Acceptance Criteria per AC 20-146

General Validation Acceptance Criteria: These criteria allow for subjective interpretation as long as this interpretation is consistent with good engineering judgment. The level of correlation required of the applicant should not be more stringent than the level of accuracy of the test data. The general validation acceptance criteria includes, but is not limited to, the following:

- The model must be validated against dynamic tests.
- The model should be utilized for conditions that are similar to the model validation conditions. Similarity should exist between the current seat analysis and the test and analysis used to validate the analysis model, including loading conditions, seat type, and worst-case conditions.
- The general occupant trajectory, verified by time history plots, should correlate against test data.
 - **Occupant Trajectory**
 - **Floor Loads**
 - **Restraint System Loads**
 - **Head Injury Criteria (HIC)**
 - **Spine Load**
 - **Femur Compressive Load (part 25 airplanes only)**



AC 20-146 – Documentation Requirements for Compliance



The applicant must create a document that provides the analytical results and comparisons to test data when computer modeling is submitted as engineering data. This document will be known as the Validation and Analysis Report (VAR). The VAR defines the methodology used to demonstrate compliance to 14 CFR parts 23, 25, 27, or 29, §§ 23.562, 25.562, 27.562, or 29.562. The VAR addresses these methodologies when computer modeling results are submitted as engineering data..

- Purpose of Computer Model
- Overview of Seating System
- Seat Structure
- Restraint System
- Unique Energy Absorbing Features in the Installation
- Software and Hardware Overview
- Description of Computer Model
- Engineering Assumptions
- Finite Element Modeling of the Physical Structure
- Material Models
- Constraints
- Load Application
- Occupant Simulation
- General Analysis Control Parameters
- Analytical Result Interpretation
- Energy Balance
- Data Output
- Data Filtering
- Ultimate Margin of Safety



Test No	07005
Pulse	PART 25-562 Horizontal
Floor Angle	0 deg
Floor Deformation	No
Yaw Angle	No
Test Dummy	H II 50th %
Simulation Dummy	FTSS H II 50th %
Type of Belt	2 pt

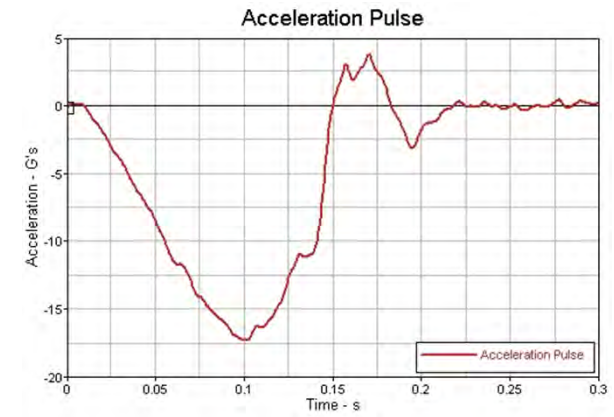

Occupant Trajectory

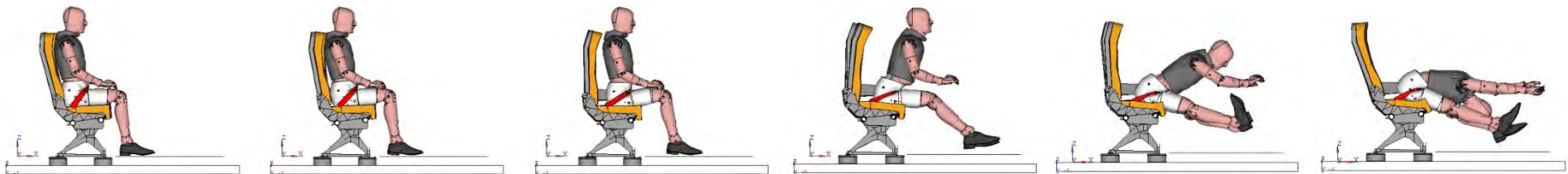
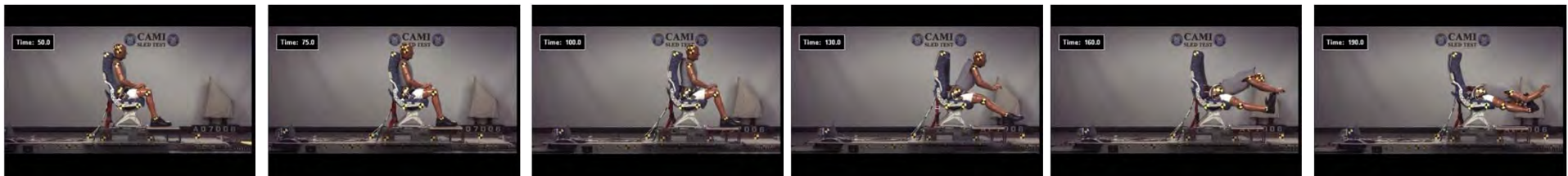

Example A: vATD Accelerations

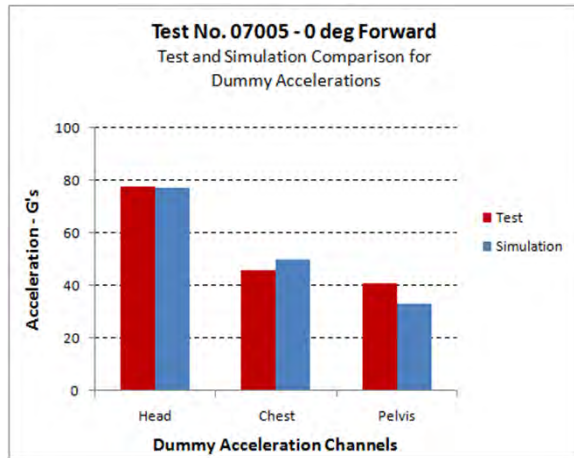

Component	Output channel	Mag. Error	Shape Error
Head	Head Resultant Acceleration	1%	6%
Chest	Chest Resultant Acceleration	9%	14%
Pelvis	Pelvic Resultant Acceleration	18%	10%

Signal Evaluation Period 175 ms

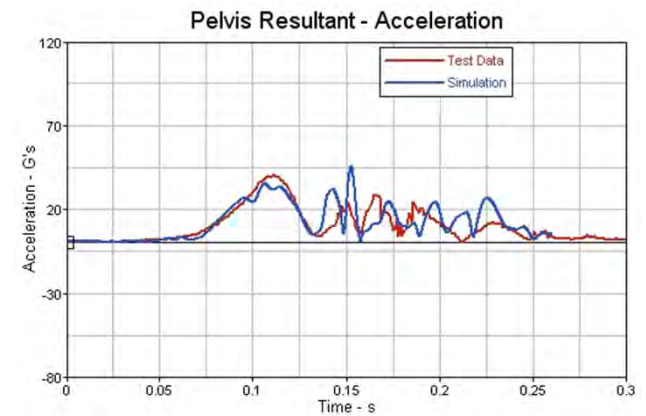
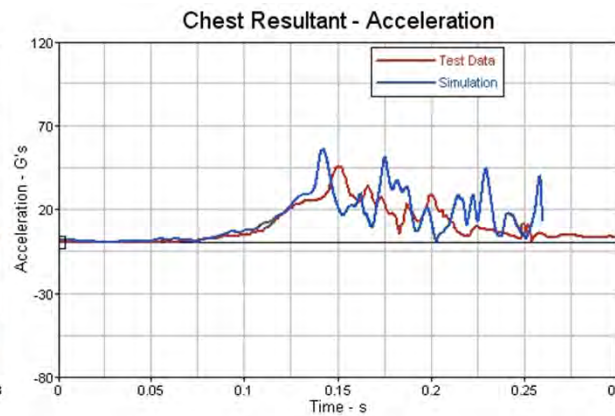
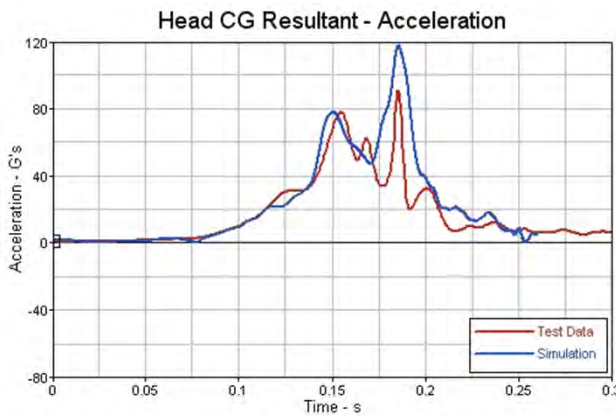

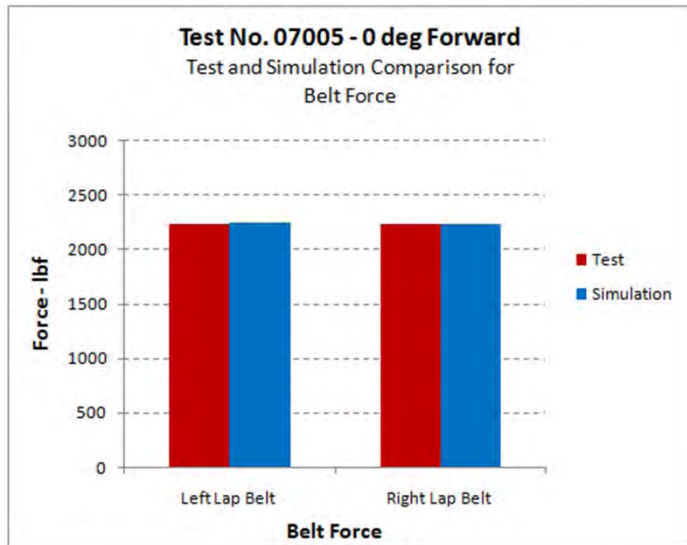

Component	Output channel	Mag. Error	Shape Error
Lap Belt	Left Lap Belt	0%	8%
	Right Lap Belt	0%	8%

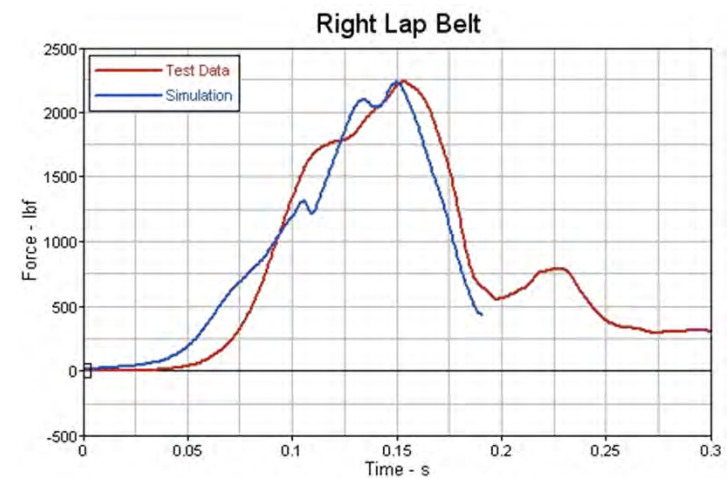
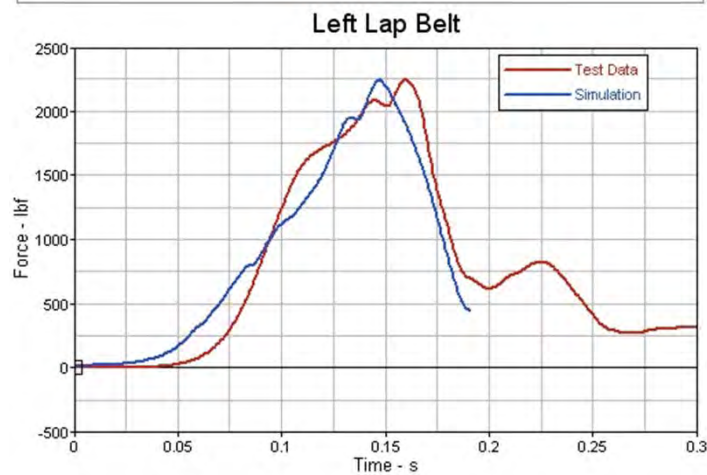

Example A: Floor Loads

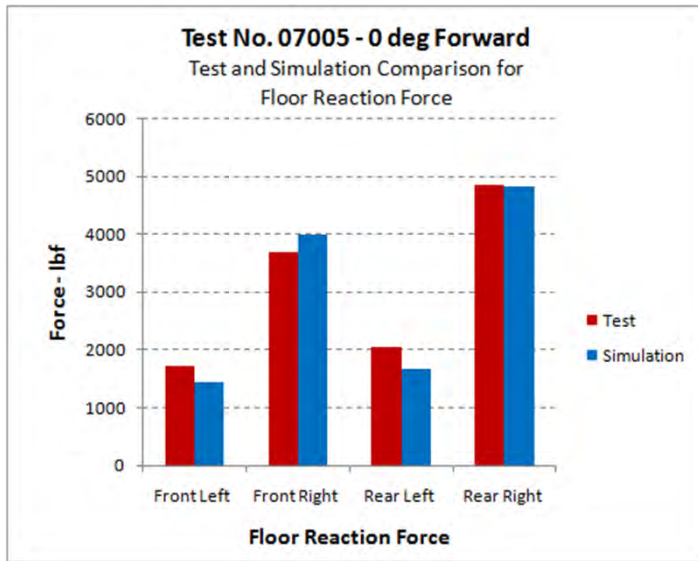

Component	Output channel	Mag. Error	Shape Error
Floor Loads	Front Left Leg	15%	19%
	Front Right Leg	9%	9%
	Rear Left Leg	18%	20%
	Rear Right Leg	1%	9%

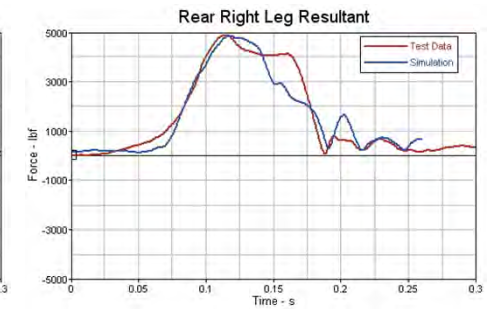
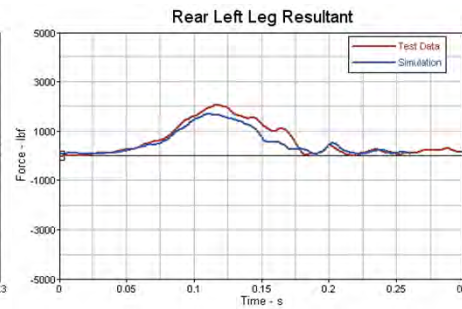
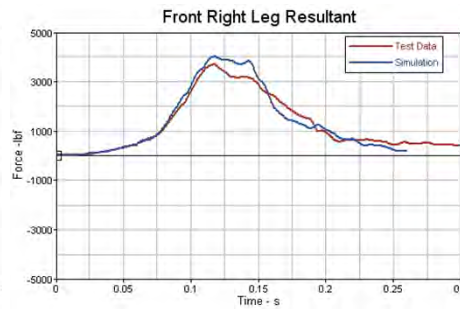
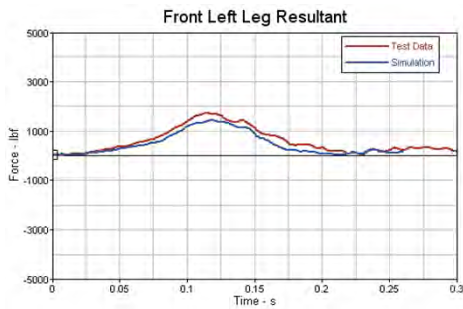

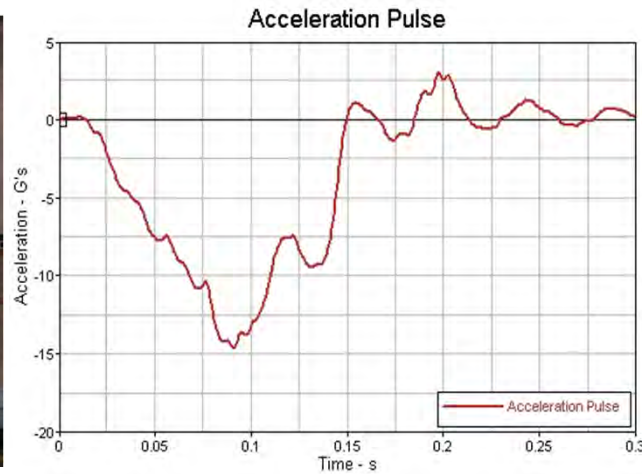
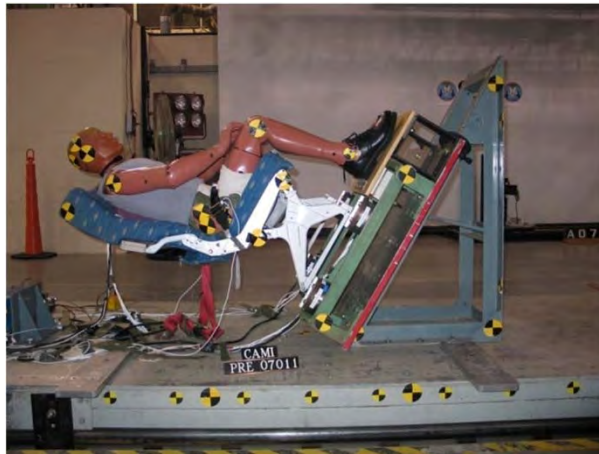

Test No	07011
Pulse	PART 25-562, Vertical
Floor Angle	60 deg
Floor Deformation	No
Yaw	No
Test Dummy	H II 50th %
Simulation Dummy	FTSS H II 50th %
Type of Belt	2 pt

Occupant Trajectory

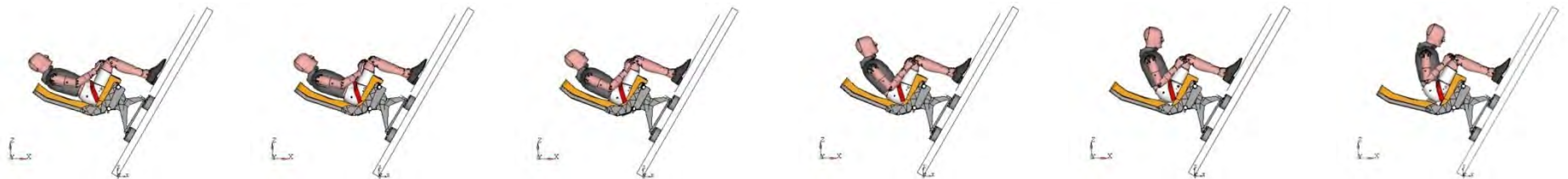
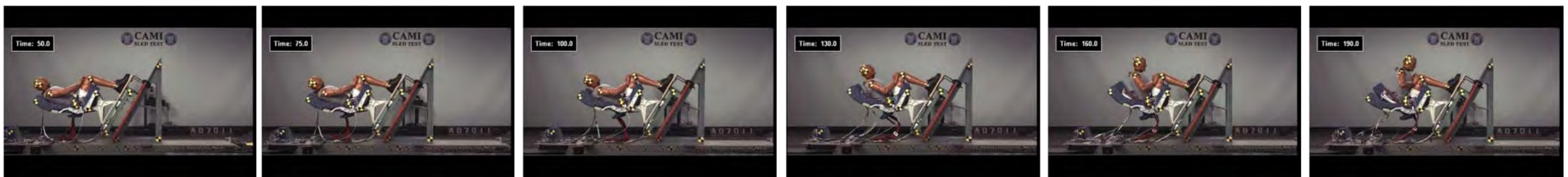

JAMS Example B: vATD Accelerations

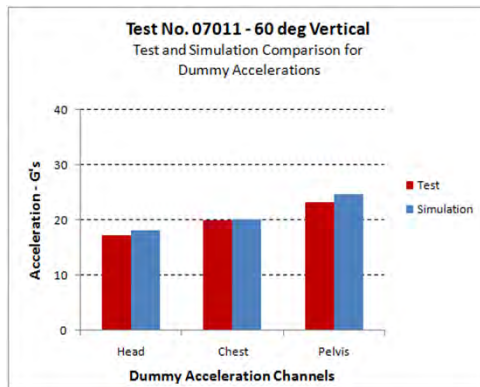

Component	Output channel	Mag. Error	Shape Error
Head	Head Resultant Acceleration	6%	7%
Chest	Chest Resultant Acceleration	0%	11%
Pelvis	Pelvic Resultant Acceleration	6%	7%

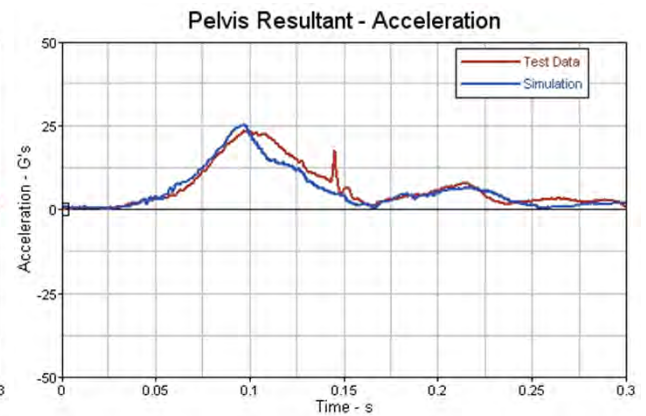
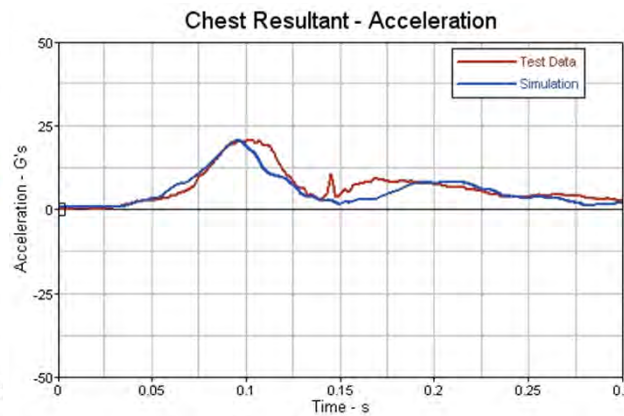
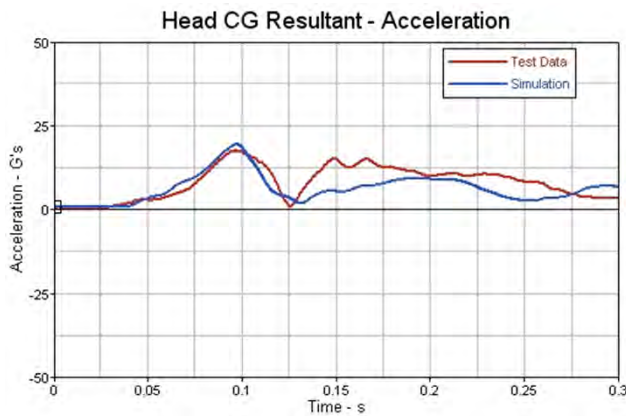

JAMS Example B: vATD Lumbar Load

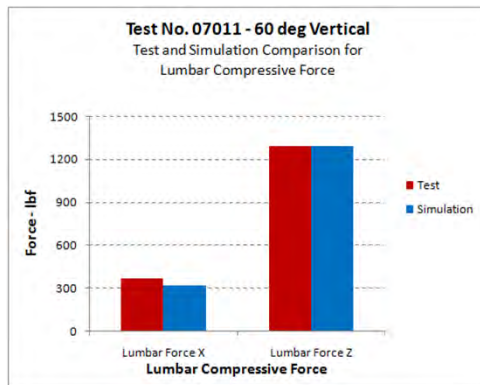

Component	Output channel	Mag. Error	Shape Error
Lumbar	Lumbar Force X	12%	16%
	Lumbar Force Z	0%	8%

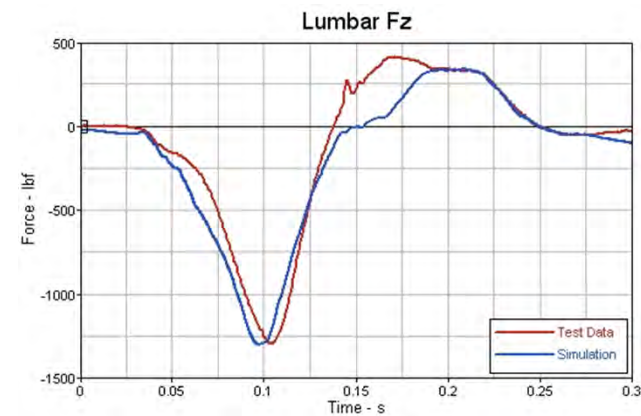
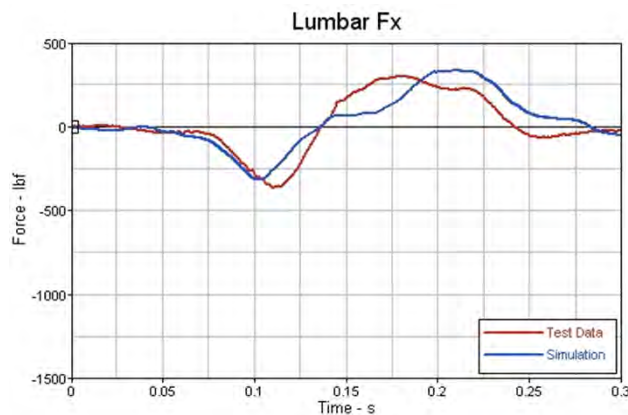

Example C: Pitch and Roll

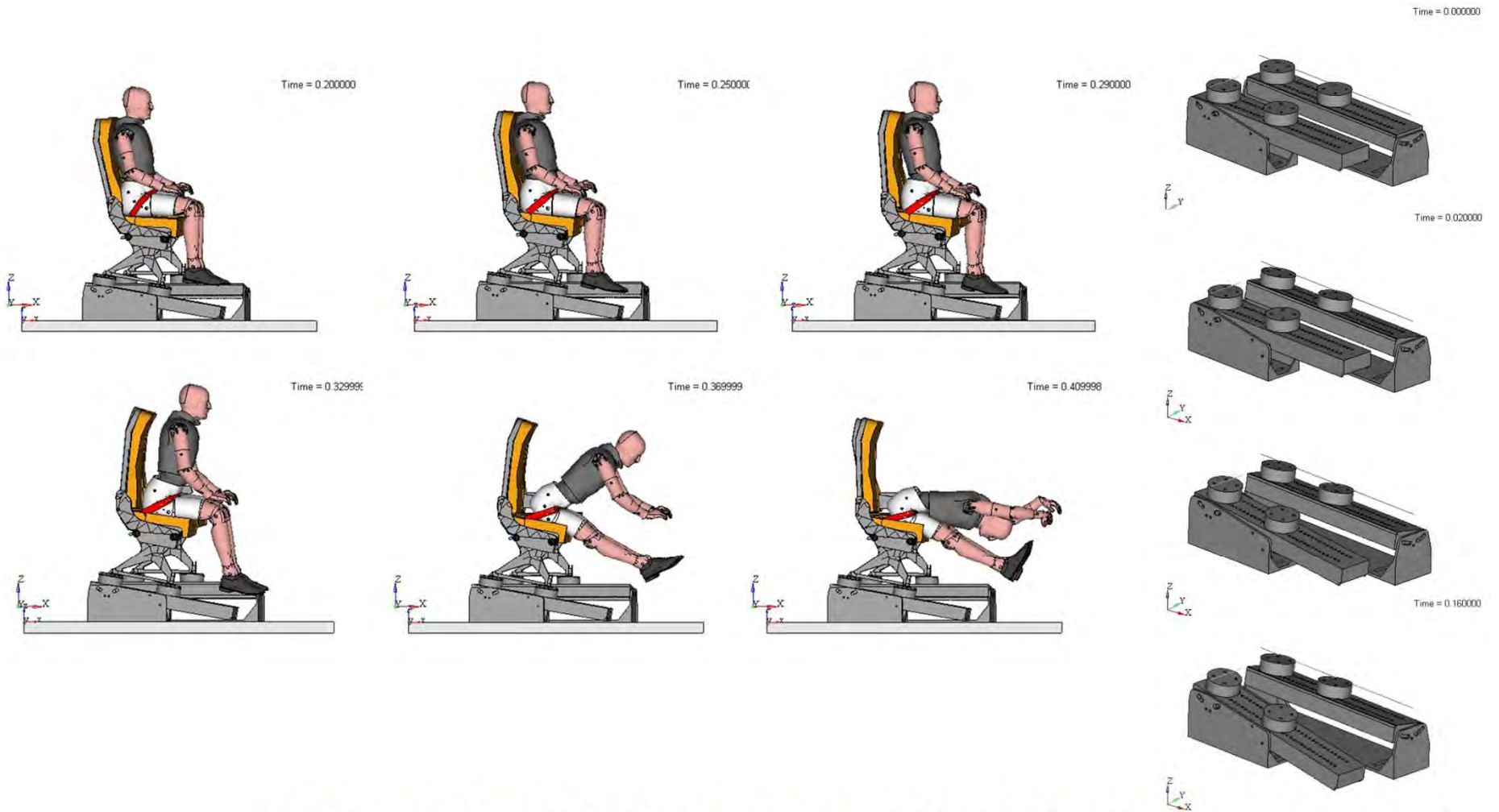

JAMS Example D: Other Applications

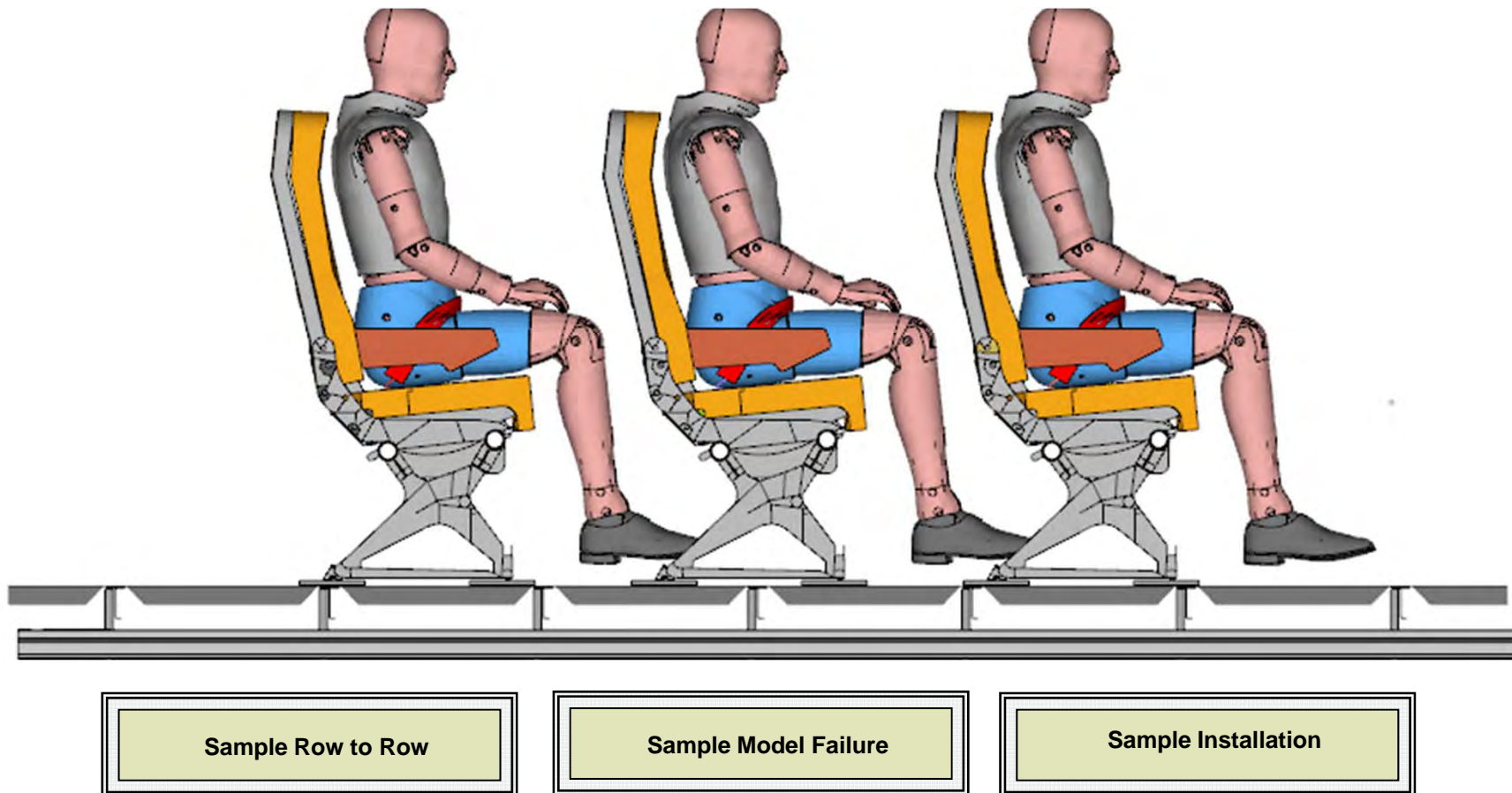

- Ten types of seats (two and three place coach seats, one first class seat, five business jet seats and two side facing seats) have been modeled and analyzed for FAR 25.562 or 23.562 dynamic test conditions:
 - For typical coach type seats, part 25.562 testing applications quasi-static material data provides acceptable results. Strain rates less than 0.7 /s for both experimental and numerical models.
 - For heavier seat structures (first class and business jet seats under FAR 25.562 or 23.562 test conditions), certain structural components may have to be defined with strain rate dependent data. The strain rate for the numerical models analyzed did not exceed 12 /s.
- Definition of recommended component testing protocols for:
 - Seat Cushion Testing – quasi static and dynamic testing. ✓
 - Metallic Component Material Testing – quasi static and high strain rate testing. ✓
 - Seat Belt Webbing Testing. ✓
- Definition of standard seat modeling and validation practices
- Technology Transfer:
 - Participation SAE Seat Committee.
 - Strain rate study results presented and submitted to SAE ARP 5765 WG.
 - Support development and validation efforts of numerical models for seat and aircraft manufacturers.
 - Technical Report. (ongoing)
 - Seat modeling workshops.
 - SAE ARP 5765 WG meetings hosted at NIAR.

CBA II Research Program Overview

- **Phase I: Airframe Crashworthiness Evaluation*** by Analysis [July 2009 –September 2010]:
 - Evaluation coupon level material testing variability – Composites (Fiberglass, Toray-Carbon Uni, Toray Carbon Fabric) and Metallic Materials (Al 7075-T6)
 - Coupon Level Material Model Validation – Composites and Metallic Materials
 - Literature review NTSB aircraft crash data
 - Develop an energy based analytical method to define stiffness, crush zone, and deceleration profiles
 - Metallic airframe preliminary crashworthiness evaluation – Hard Surfaces, Soft Soil and Water Impact
 - Propose Airframe Crashworthiness Evaluation Methodology
- * Note there are no current requirements for airframe crashworthiness, only special conditions with the introduction of composite fuselages (equivalent level of safety to metallic structures).

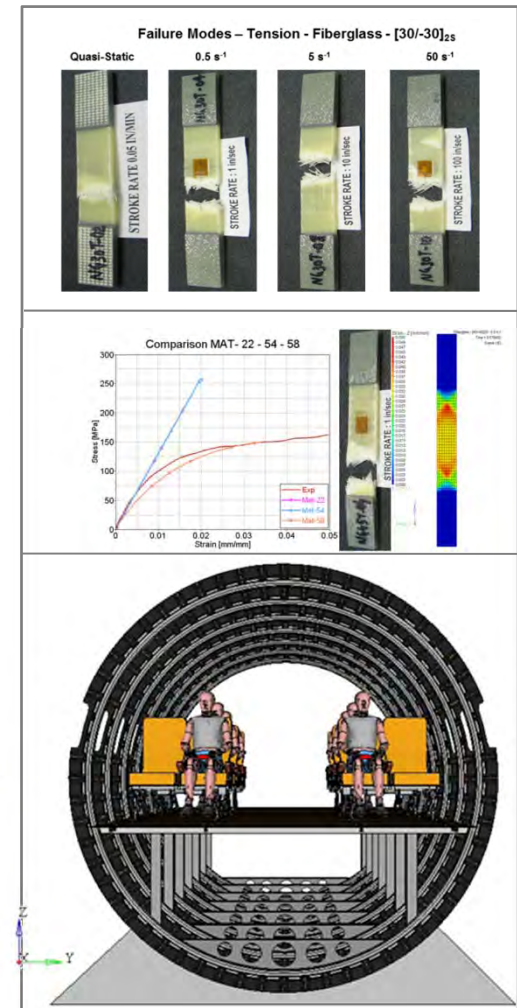

CBAI: Composite Structures Crashworthiness

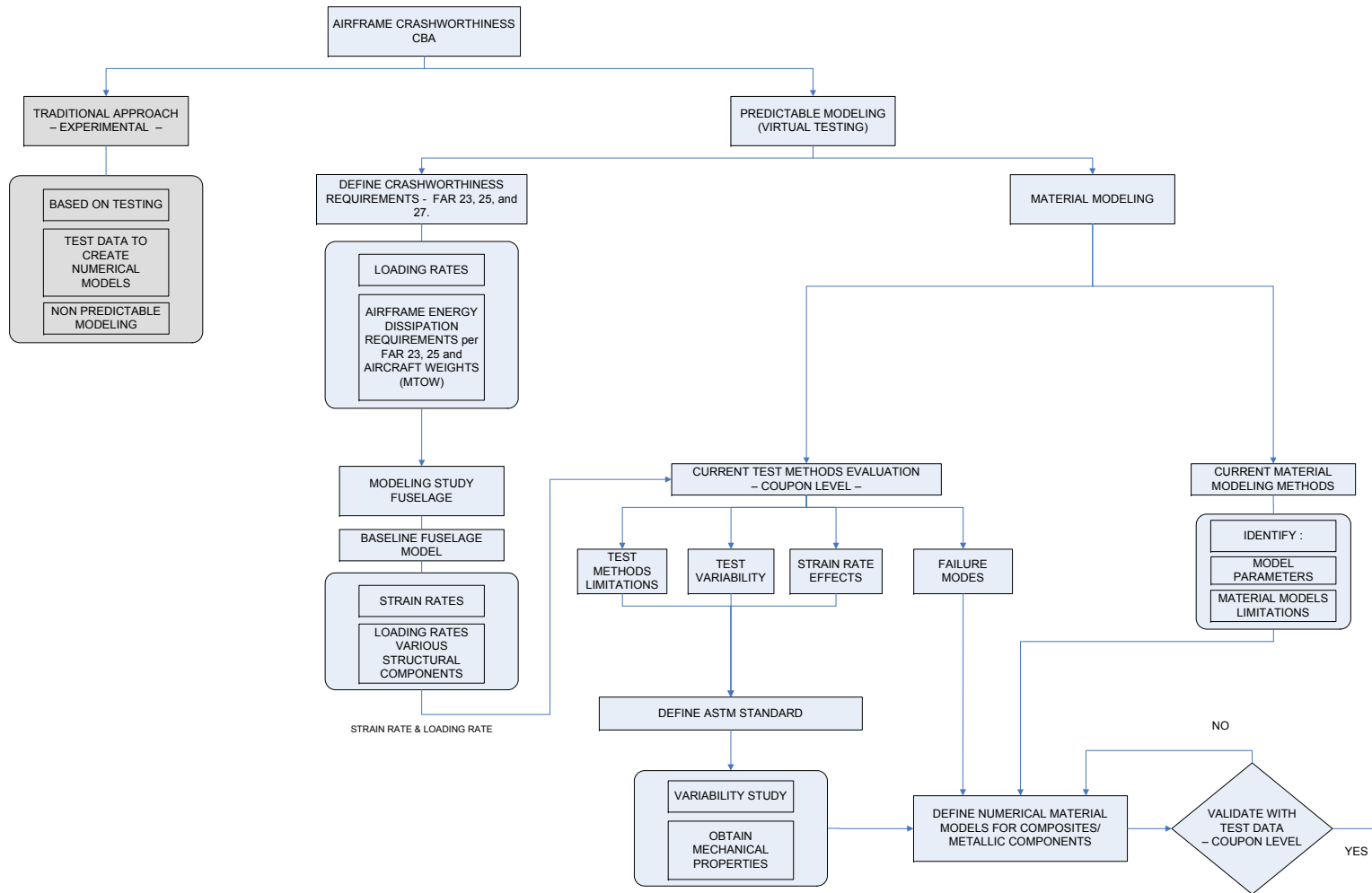

CBA II Composite Structures Crashworthiness – cont.

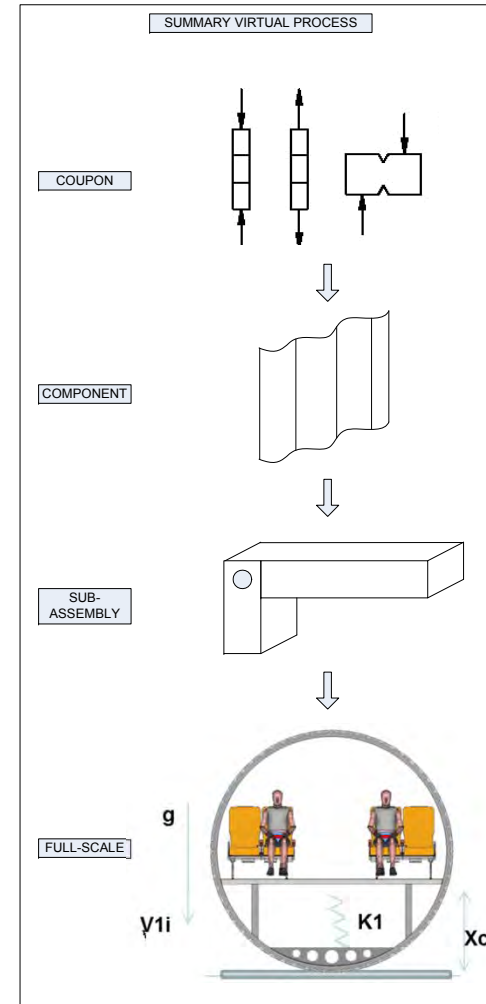
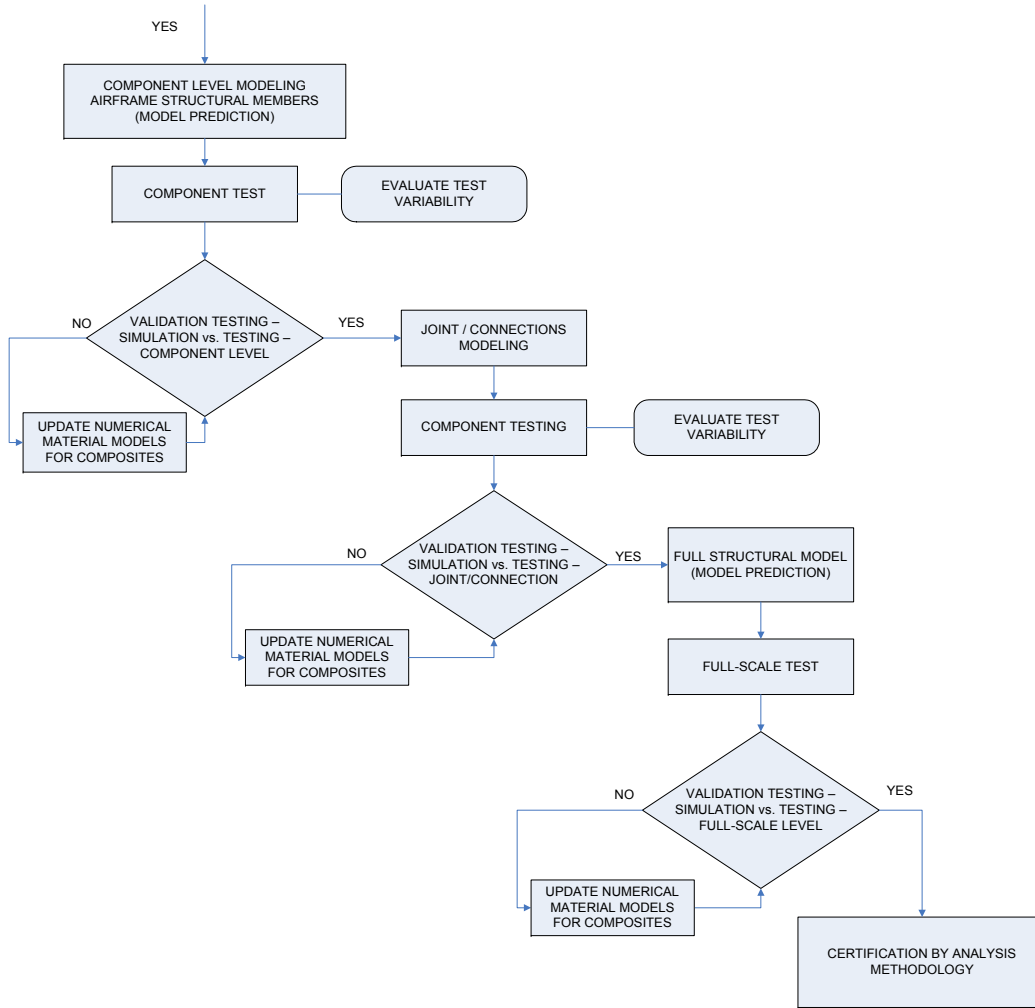

Impact Dynamics – Vertical Drop Test

EQ.1 Initial Energy prior to impact:

$$E_{in} = \frac{1}{2} \cdot (M_1 \cdot V_{li}^2) + M_1 \cdot g \cdot h$$

EQ.2 Since the PE is low compared with the KE:

$$E_{in} = \frac{1}{2} \cdot (M_1 \cdot V_{li}^2)$$

EQ.3 The energy will be dissipated by the structure and the impacted surface:

$$E_d = \int_0^{X_{c1}} F(x)_1 \cdot dx_1 + \int_0^{X_{c2}} F(x)_2 \cdot dx_2$$

EQ.4 Lets assume the surface is rigid and there is no penetration in the impacted surface:

$$E_d = \frac{1}{2} \cdot K_1 \cdot X_{c1}^2 + \frac{1}{2} \cdot K_2 \cdot X_{c2}^2$$

EQ.5 The energy balance for the impact is:

$$E_d = \frac{1}{2} \cdot K_1 \cdot X_{c1}^2$$

$$E_{KE1} + E_{PE1} = E_d + E_{KE2}$$

EQ.6 The energy balance for the impact is simplified:

$$\frac{1}{2} \cdot (M_1 \cdot V_{li}^2) \approx \frac{1}{2} \cdot K_1 \cdot X_{c1}^2$$

The two critical airframe design parameters are Xc1 and K1:
Material, EA geometry, structure design layout, impact condition

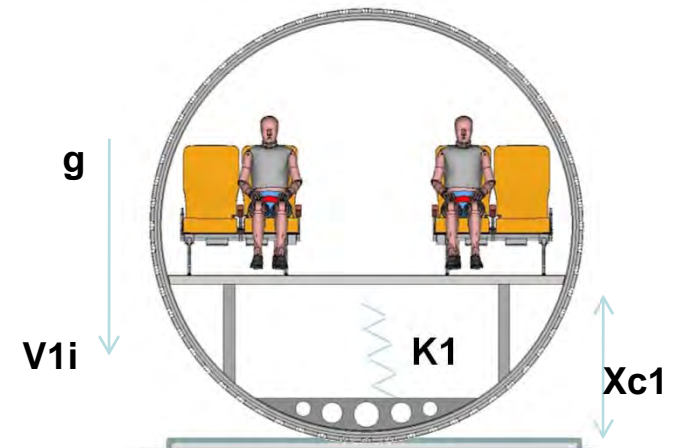

Composite Structures Crashworthiness Design Parameters

- Crashworthiness performance of composite structures to be equivalent or better than traditional metallic structures
- Crashworthiness design requirements;
 - Maintain survivable volume
 - Maintain deceleration loads to occupants
 - Retention items of mass
 - Maintain egress paths
- Design Parameters
 - Mass
 - Impact Velocity: horizontal and vertical component (for survivable accidents)
 - Impact surface: hard, soft soil, water...
 - Aircraft impact area
 - Sub-Floor Structure and crush distance
 - Material Selection
 - Subfloor Configuration: Fuel Tanks, Cargo
 - Aircraft Type

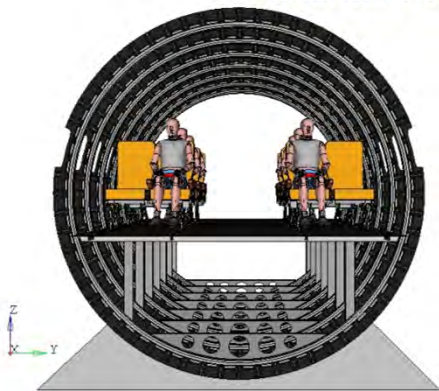

JAMS Data Analysis FAA Drop Tests

- Four tests were conducted for four regional commuter planes: ATR 42-300, Short Brothers 3-30, Beechcraft 1900C, and Raytheon/Fairchild Metro III

	B1900C	SHORTS 3-30	METRO III	ATR 42	
Mass Aircraft	3402	9616	3856	15059	kg
Vo	9.14	9.14	8.23	8.23	m/s



NIAR Preliminary Data Analysis

	B1900C	SHORTS 3-30	METRO III	ATR 42		
Mass Aircraft***	3402	9616	3856	15059	kg	
Vo***	9.14	9.14	8.23	8.23	m/s	
Dynamic Crush***	0.0508	0.10922	0.09906	0.41656	m	
KE in	142222	402015	130560	509952	Joules	
PE in	1695	10303	3747	61539	Joules	
Analytical	Dynamic Linear Structural Stiffness	1.10E+08	6.74E+07	2.66E+07	5.88E+06	N/m
	Energy Dissipated by Structure**	142222	402015	130560	509952	Joules
	t (crash event)	0.0111	0.0239	0.0241	0.1012	s
	a avg (crash event)	83.9	39.0	34.8	8.3	g
Test Data	t (Peak Pulse Test)***	0.009	0.017	0.031	0.084	s
	Peak Pulse ΔV***	7.01	7.62	8.23	7.92	m/s
	a avg peak pulse	79	46	27	10	g
	Lumbar Spine*	2500	3050	2800	1250	lbf

* Calculated by simulation HII Comfort Green Seat Cushion (FAR*.562 Limit 1500 lbf)

** Energy Balance Check

*** FAA Report

$$t = \frac{2 \cdot \sqrt{\frac{M \cdot V_{li}^2}{K_1}}}{V_{li}} \quad K_1 = \frac{(M_1 \cdot V_{li}^2)}{X_{c1}^2} \quad a_{avg} = \frac{V_{li}}{2 \cdot \sqrt{\frac{M \cdot V_{li}^2}{K_1}}} \quad X_{c1} = \sqrt{\frac{(M_1 \cdot V_{li}^2)}{K_1}}$$

NIAR Generic Fuselage Model - Metallic

- **Objectives:**

- Study the behavior of a metallic structure for various crash configuration: Impact velocities, angles, surfaces (water, soil..)
- Subfloor configurations (Cargo, Fuel Tank..)
- Define loading rates, strain rates and crash energy management for various components (skin, stanchions, frames...),
- Evaluate occupant kinematics and injuries.
- Focus the coupon and component level research to the proper design requirements (i.e. loading rates, loading conditions), define composite material type definitions for EA applications.

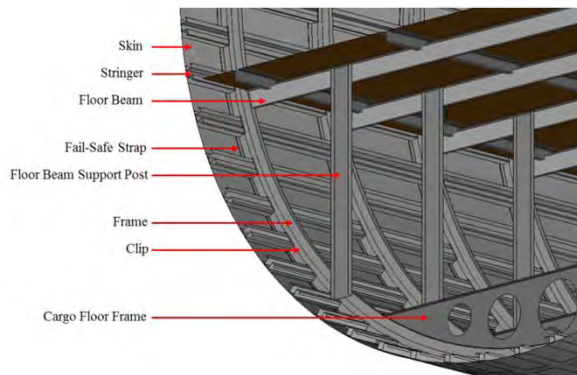

Example Kinematics Metallic Fuselage to Hard Surface – 30 ft/s

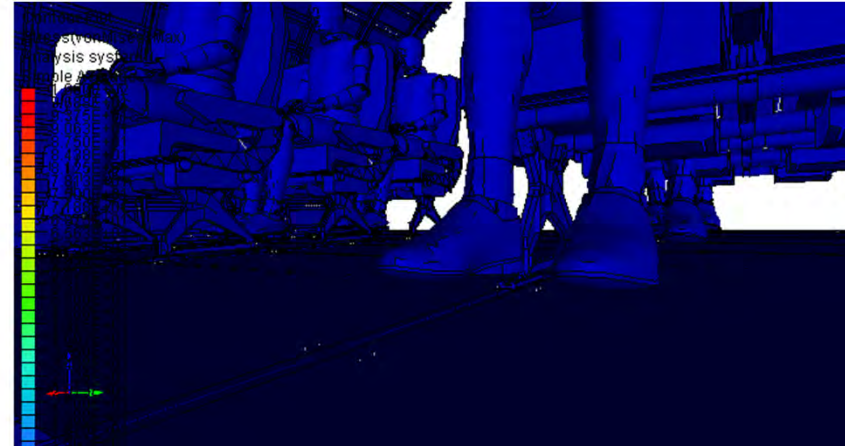
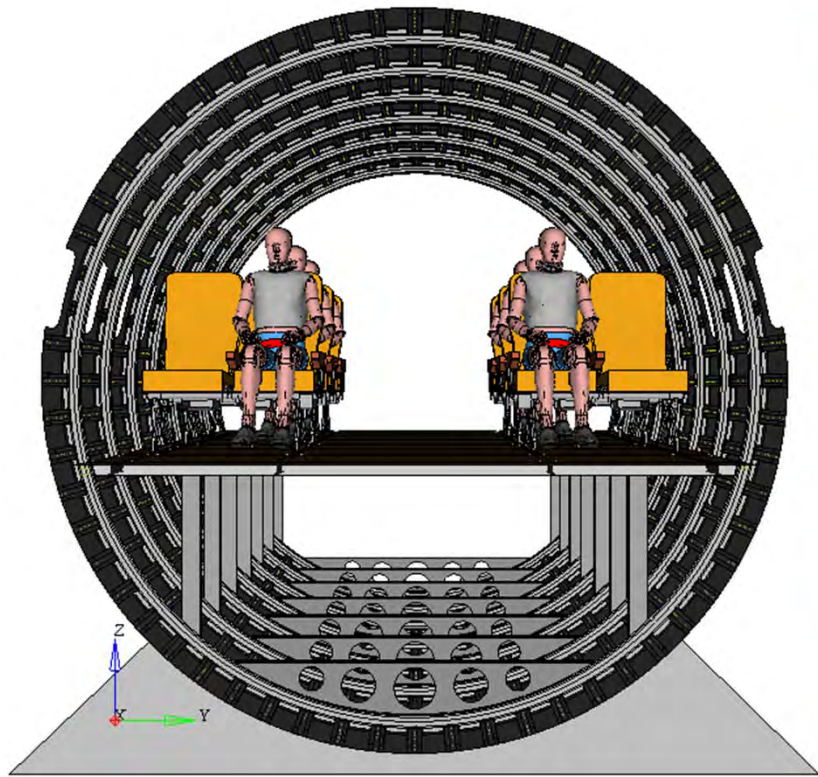

Contour Plot
 Stress(vonMises, Max)
 Analysis system
 Simple Average

1.000E+02
9.688E+01
9.375E+01
9.063E+01
8.750E+01
8.438E+01
8.125E+01
7.813E+01
7.500E+01
7.188E+01
6.875E+01
6.563E+01
6.250E+01
5.938E+01
5.625E+01
5.313E+01
5.000E+01
4.688E+01
4.375E+01
4.063E+01
3.750E+01
3.438E+01
3.125E+01
2.813E+01
2.500E+01
2.188E+01
1.875E+01
1.563E+01
1.250E+01

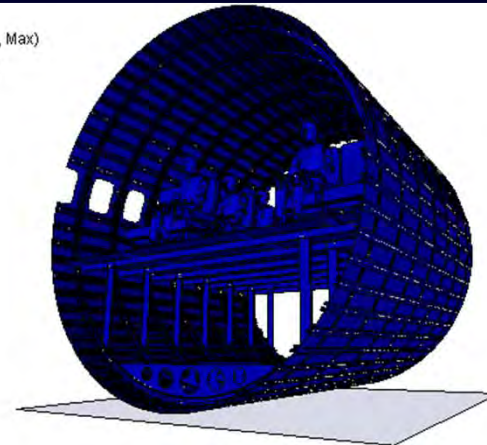

Example Kinematics Metallic Fuselage to Hard Surface – 30 ft/s

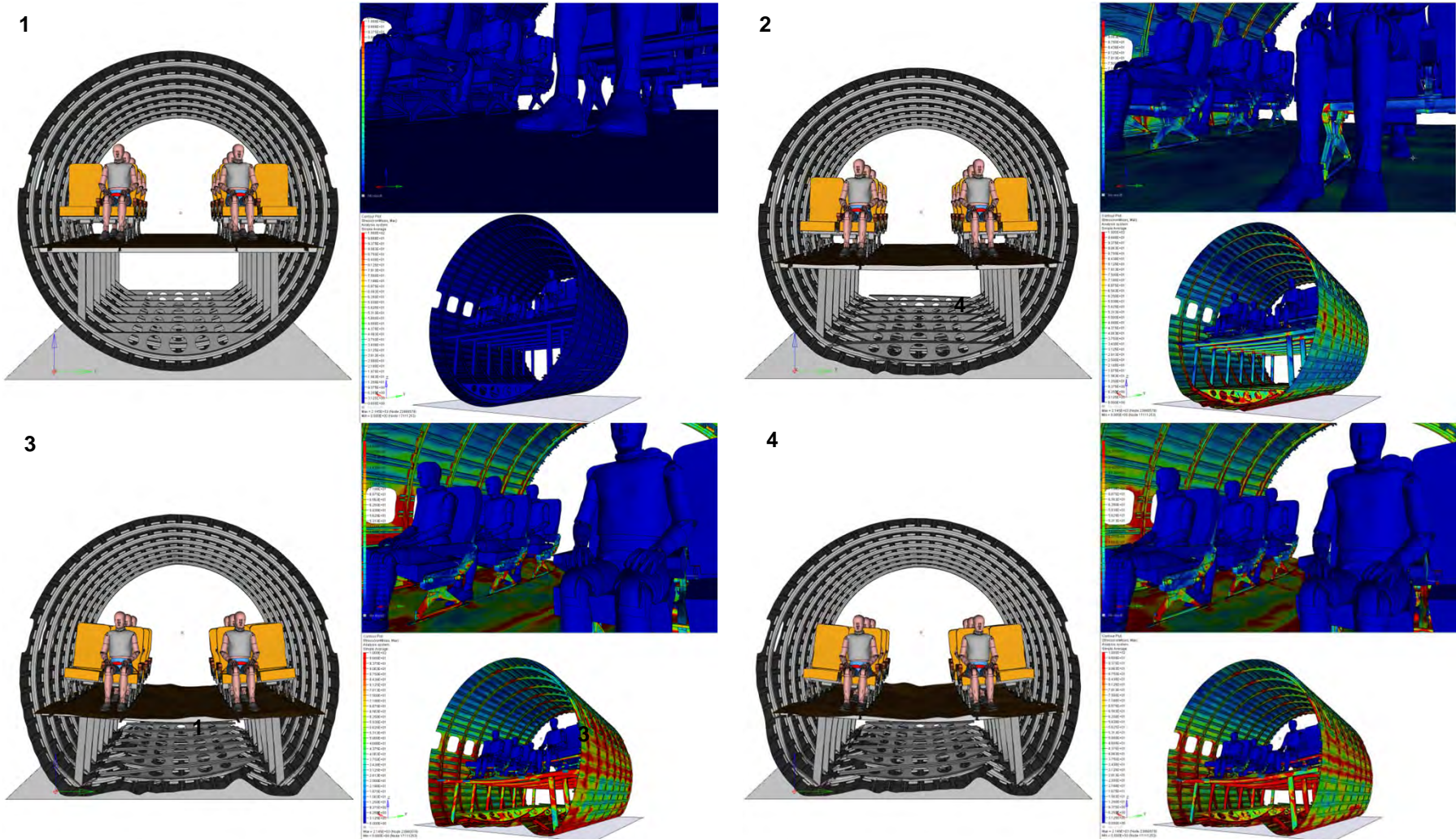

Example Kinematics Metallic Fuselage to Hard Surface / Water – 30 ft/s

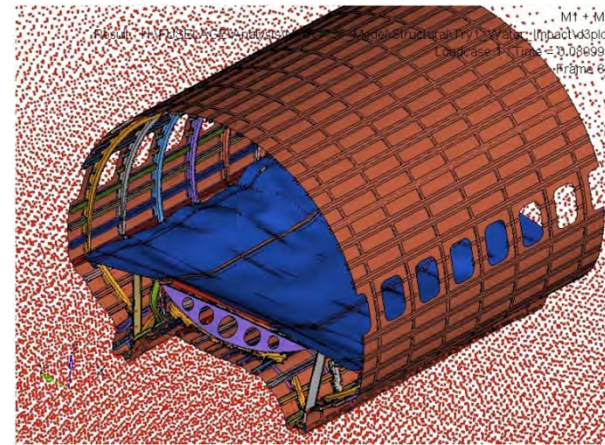
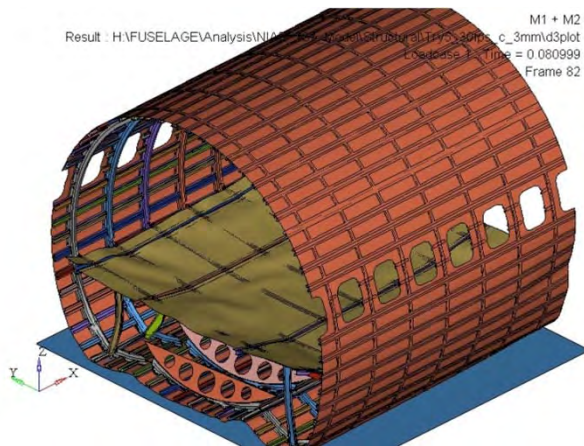
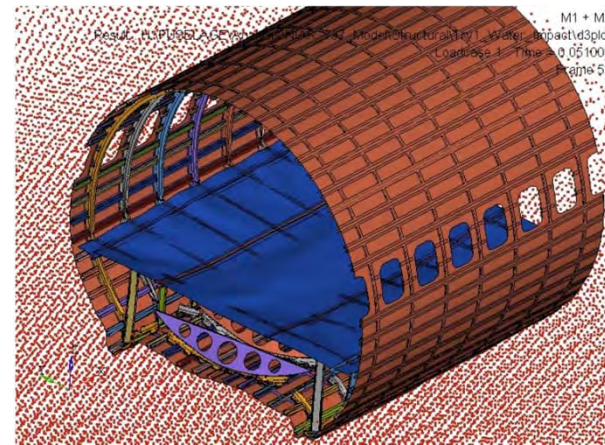
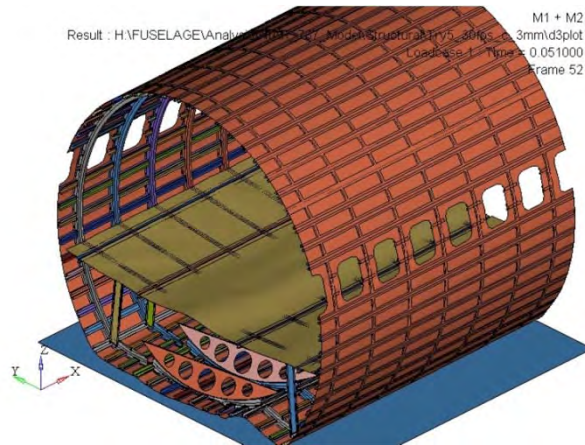

- Evaluation coupon level material testing variability – Composites (Fiberglass, Toray-Carbon Uni, Toray Carbon Fabric) and Metallic Materials (Al 7075-T6)
- Current testing practices do not provide all the data required for simulation:
 - Strain measurements (Strain Failure): limited by strain gage measurement capabilities and SG bonding procedures/techniques.
 - Ultimate strength measurements: limited by “ringing” observed in piezo-electric and piezo-resistive load cells. This issue is more noticeable at higher loading rates.

- Strain gage operational range – large deformation materials
- Early debonding/peeling from composite specimen
- Alternative methods still in a development stage
 - Digital Image correlation methods can be used

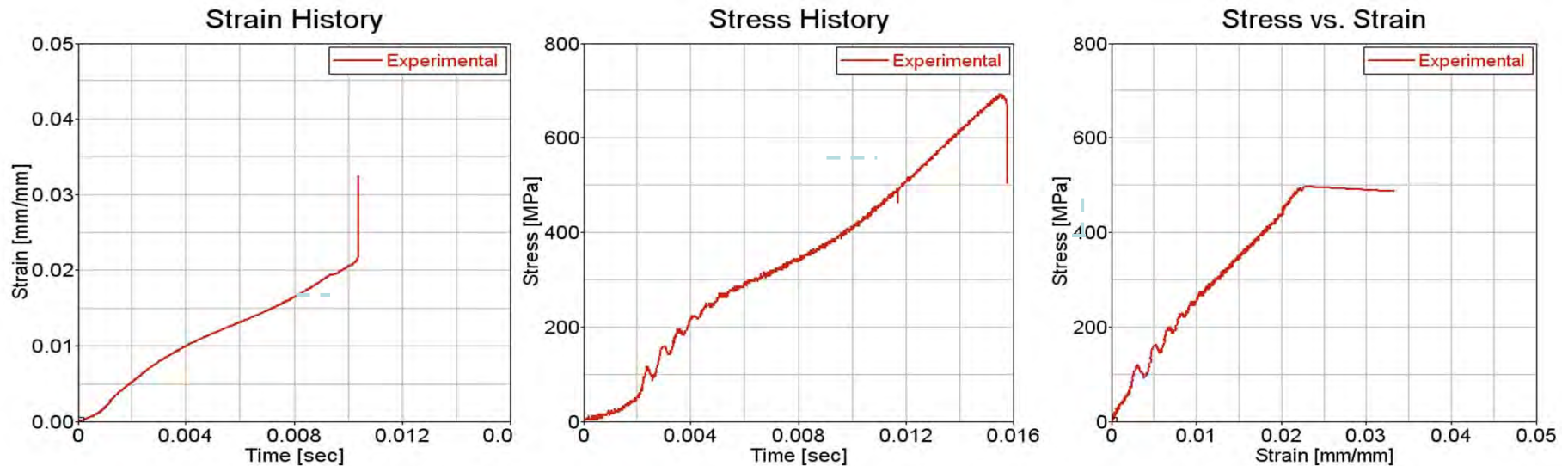

Strain and Stress history – Fiberglass [0]₄ – Strain-rate 5 s⁻¹

- Low natural frequency of load cells perturbs measurement
 - Large oscillations are introduced in the force signal - “ringing”
 - Uncertainty about stress history – $\sigma(t)$
 - Filtering or smoothing
 - May hinder the strain-hardening behavior – metals
 - Uncertainty about actual failure strength – composites
 - Alternatives
 - Local measurement using strain gages – limited to metals

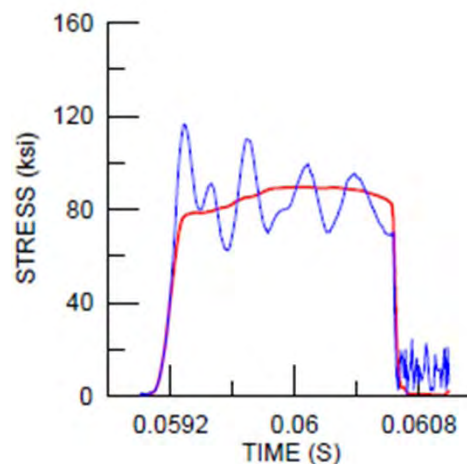
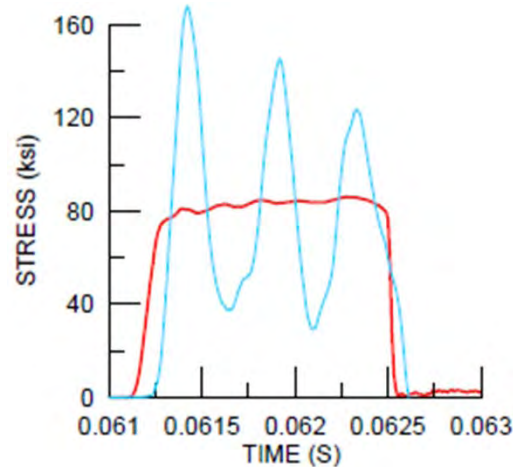

STRESS HISTORY – AI 7075-T6
 Nominal Test Speed 100 in/s

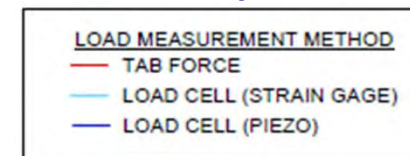

JAMS Testing Variability - Fiberglass

Tensile Failure Strength - Fiberglass

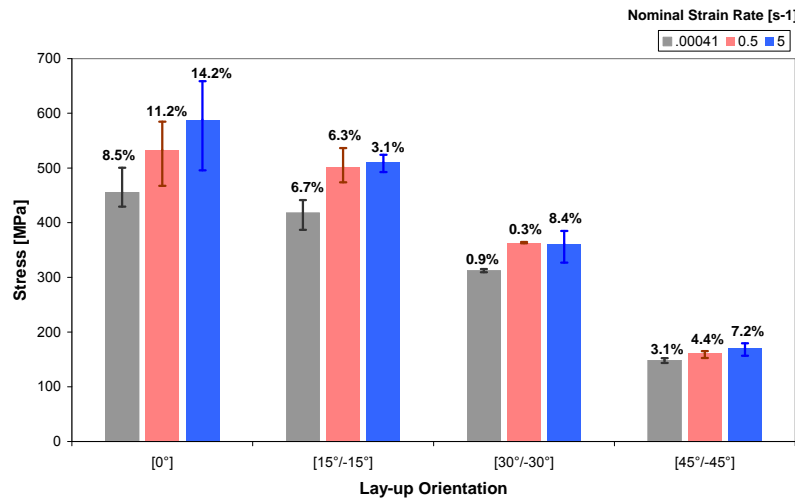

Failure Modes – Tension - Fiberglass - [30/-30]_{2S}

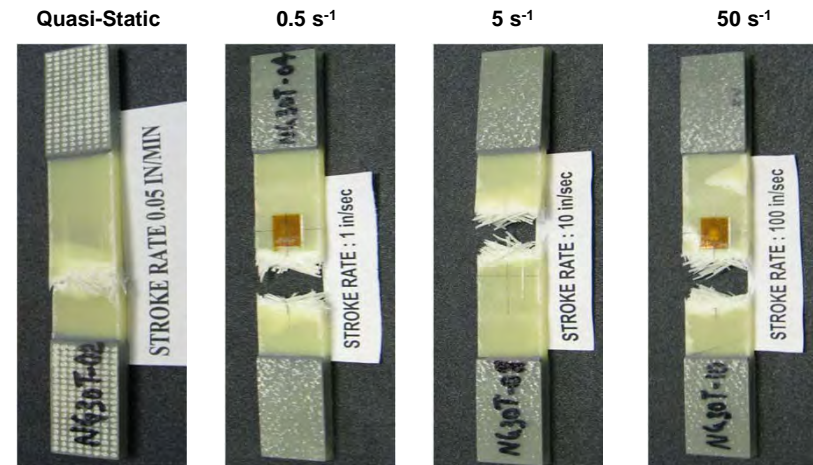

Modulus of Elasticity - Tension - Fiberglass

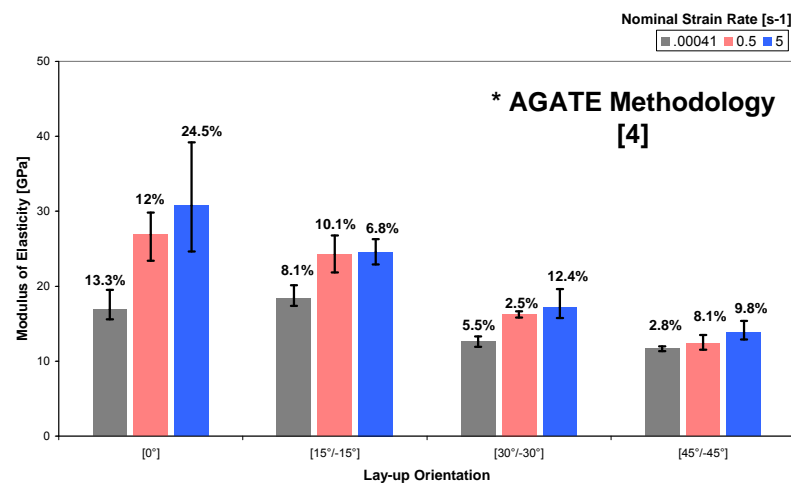

Strain-Rate - Tension - Fiberglass

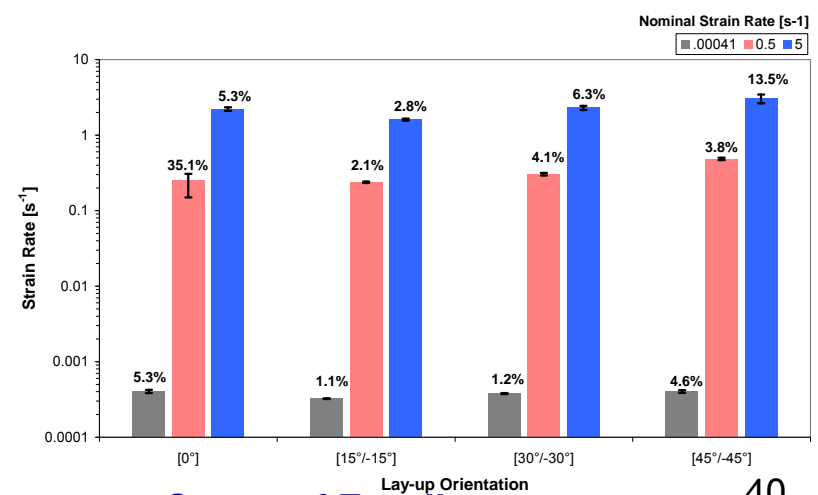

JAMS Testing Variability – Al 7075-T6

Tensile Failure Strength - Al 7075-T6

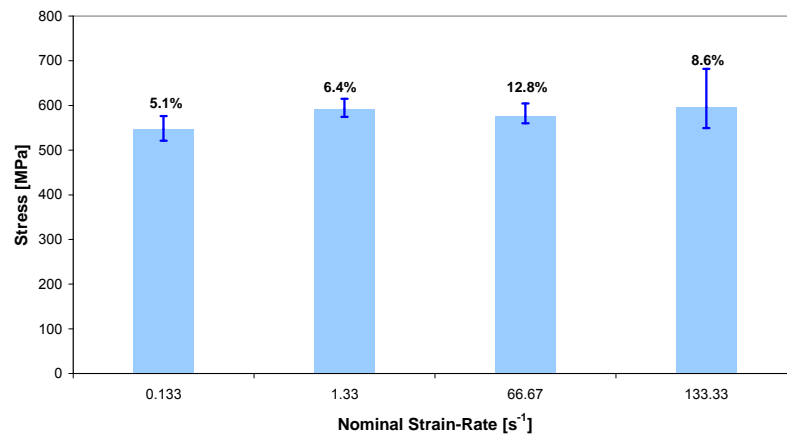

Modulus of Elasticity - Tension - Al 7075-T6

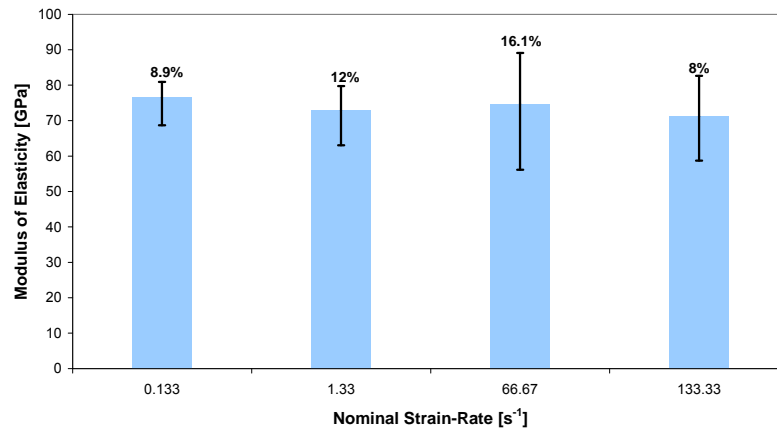

Failure Modes – Tension – Al 7075-T6

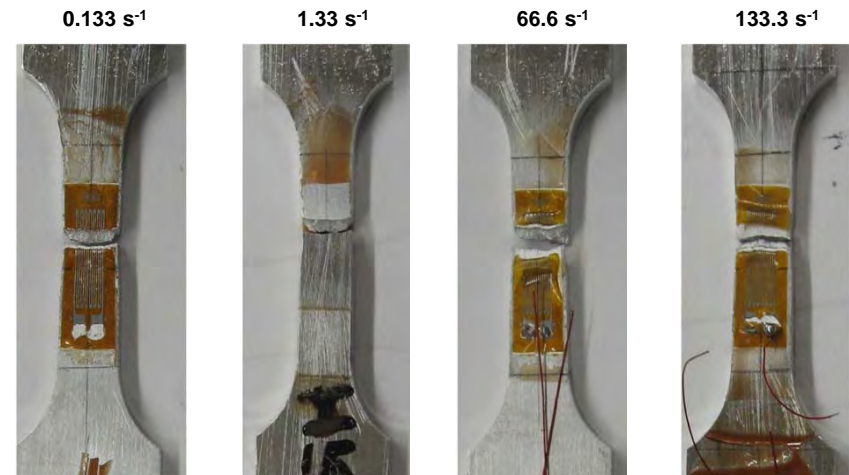

Strain-Rate - Tension - Al 7075-T6

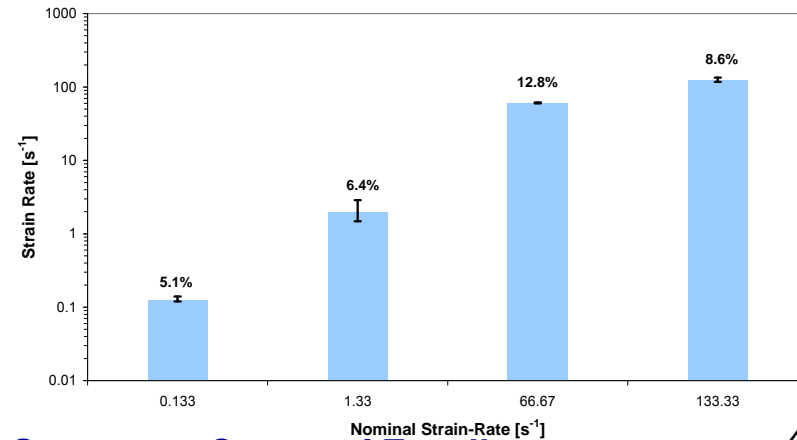

Development Test Equipment Model

- Specimen-Gripping Assembly Model
 - Numerical model for testing method improvement
 - Testing system at NIAR/WSU

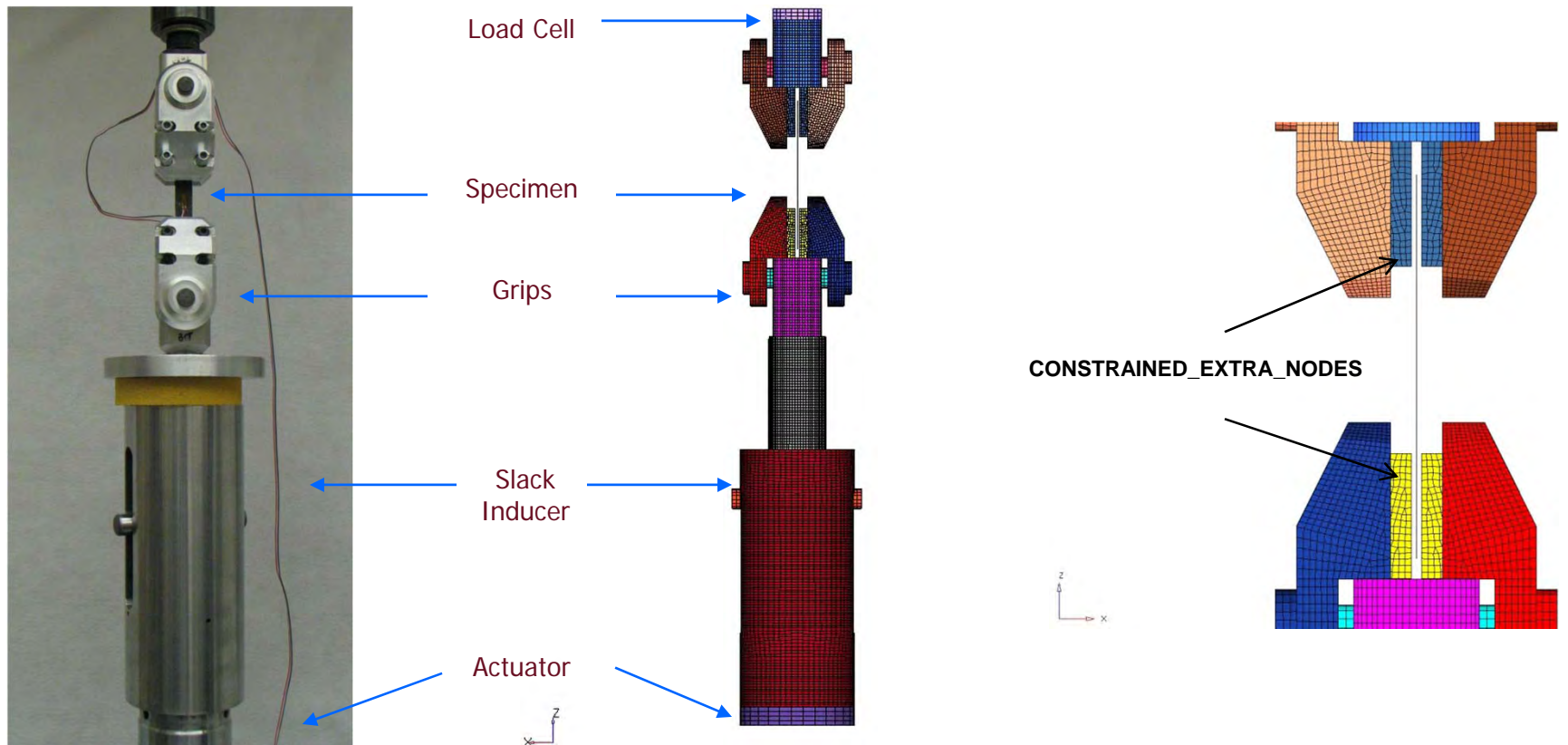

- Validation – Piecewise linear plastic material model
- Experimental Input – Eff. Stress vs. Eff. Plastic Strain

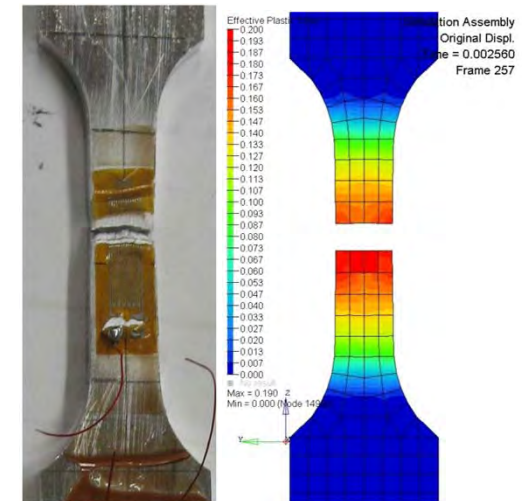
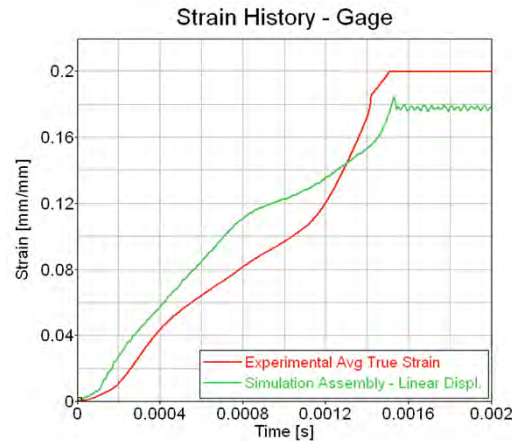
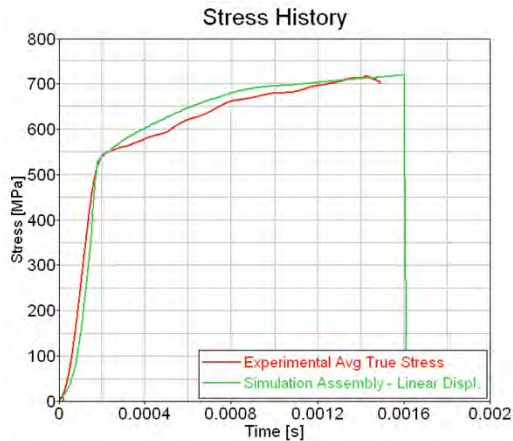

Effective Plastic Strain -133 s⁻¹

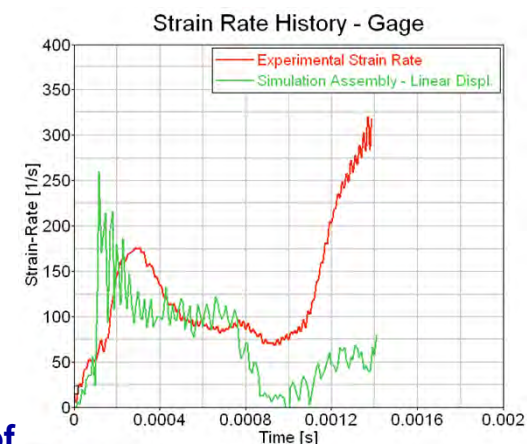
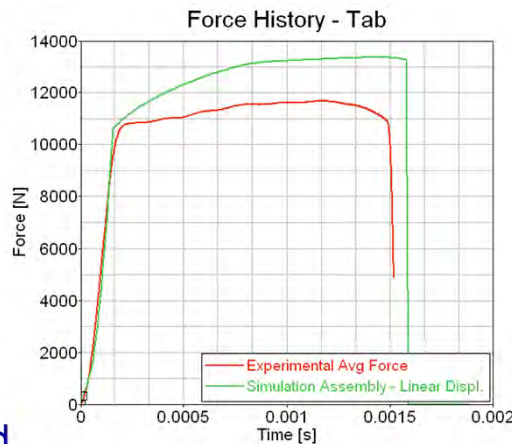
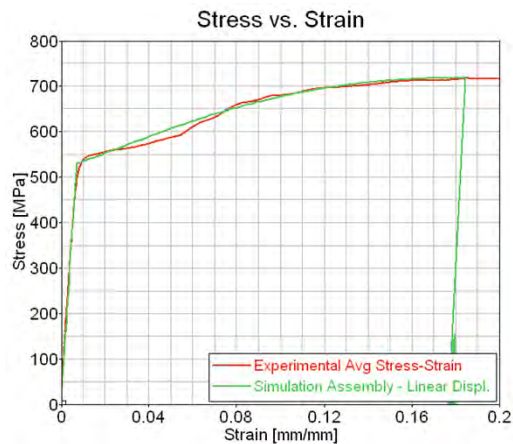

Development Test Equipment Model

- Specimen-Gripping assembly model simulation results show good agreement with experimental data over the evaluated strain rates, i.e., quasi-static to 133 s^{-1} .
- Individual response histories at the larger strain-rate of 133 s^{-1} showed some deviation from experimental results. Such behavior exposes the effect of assembly compliance in the material response.
- Further refinement of the assembly model to include detail interaction at attachment points.
- Provides a tool for evaluation of individual components effect on the material response.
- May bring clarity over issues that currently limit the testing technique, e.g. grip mass.
- Can be used to generate corrections for strain-rate sensitive materials.

JAMS Tension Testing Model Validation

- Ls-Dyna material cards MAT-22, MAT-54, and MAT-58 are compared for to characteristic material orientations, i.e., $[0]_4$ and $[45/-45]_{2S}$ for a strain-rate 0.5 s^{-1} .
- Laminated composite material are treated as linear elastic orthotropic before failure
- Materials cards differ in the pre-damage and post failure processes
 - MAT-54 reduces fiber strength to account for matrix failure and implements a progressive failure model after yield
 - MAT-58 assumes deformation introduced by micro cracks and cavities causing stiffness degradation leading to nonlinear deformation
 - MAT-58 – Faceted failure surface for comparison (FS=-1)

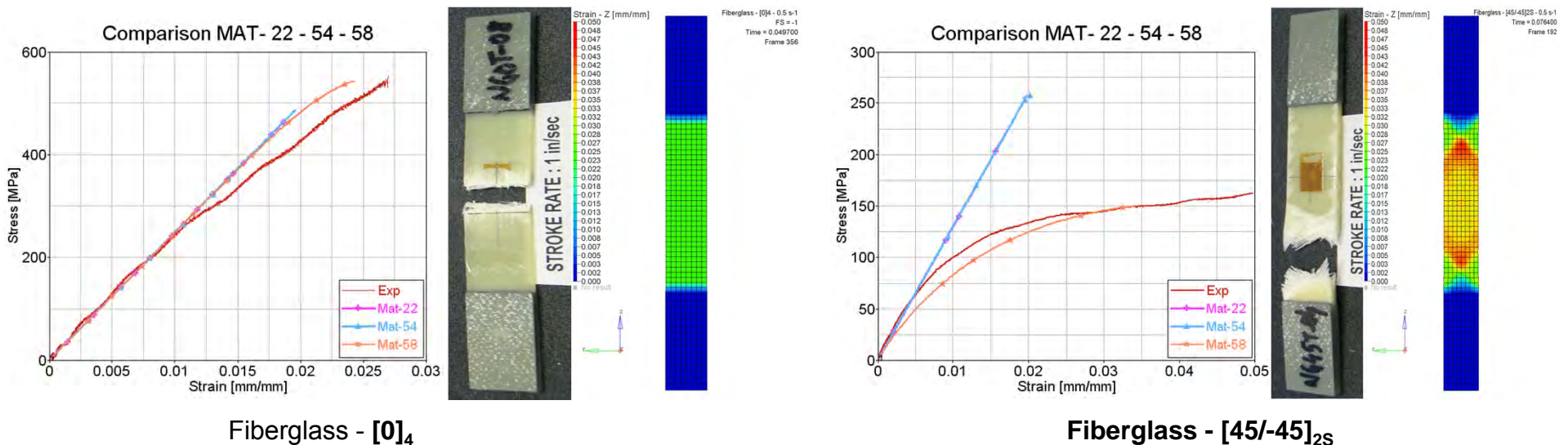

Tension Testing Model Validation

- MAT-58 matches closely the non-linearity observed by off-axis specimens without failure parameter manipulation.
- Three failure surfaces are evaluated
 - Smooth failure surface with a quadratic criterion in fiber and transverse directions, FS = 1.
 - Smooth failure surface in the transverse direction with limiting value in fiber direction, FS = 0.
 - Faceted failure surface - After strength limits damage evolves in tension and compression in fiber and transverse direction, FS = -1.

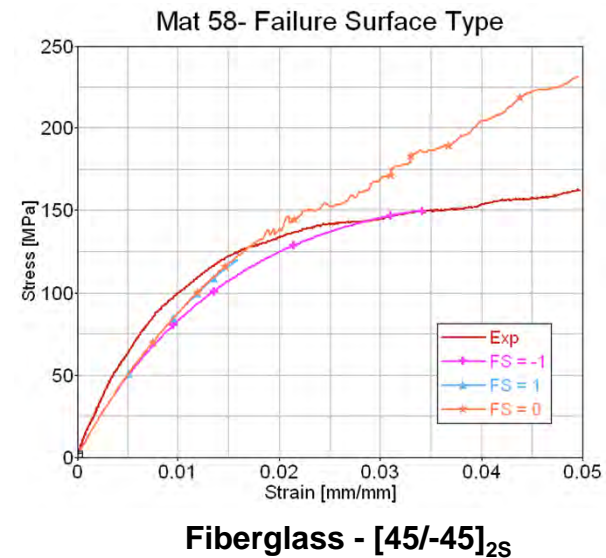
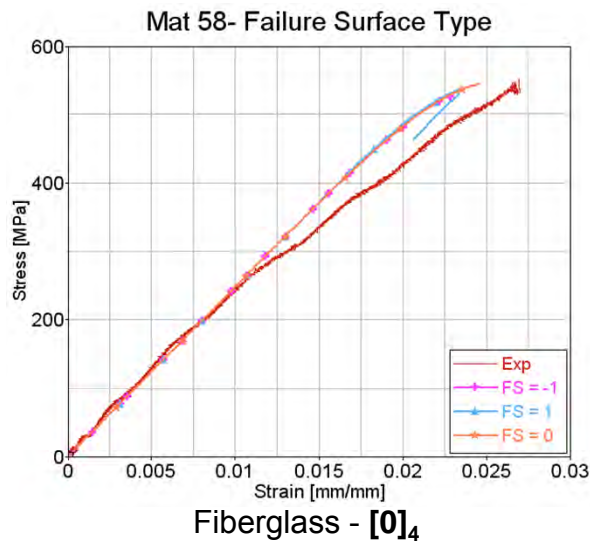

JAMS Compression Testing Model Validation

- Test method – SRM 1-94 [2] /ASTM D-695 [3]
- Material properties – AGATE[3]
- Fiberglass - $[0/90]_{3S}$
- Strain-rate of 0.0004 s^{-1} – Quasi-Static
- Ls-Dyna MAT-58 – Faceted failure surface

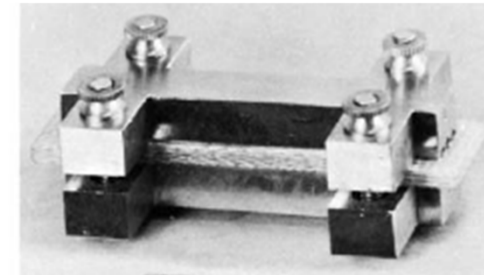

Support Jig – ASTM D-695 [3]

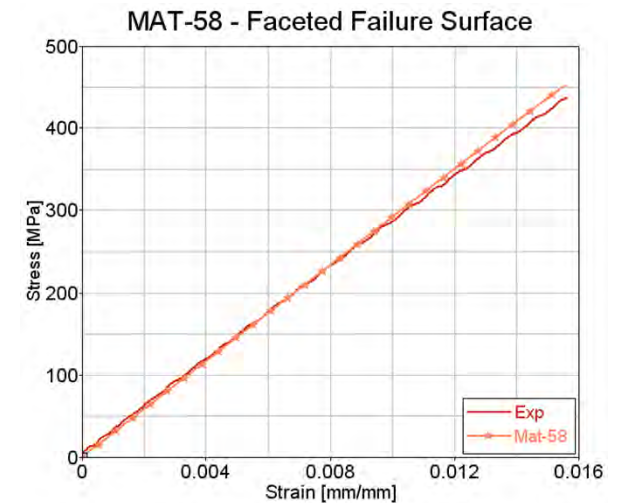
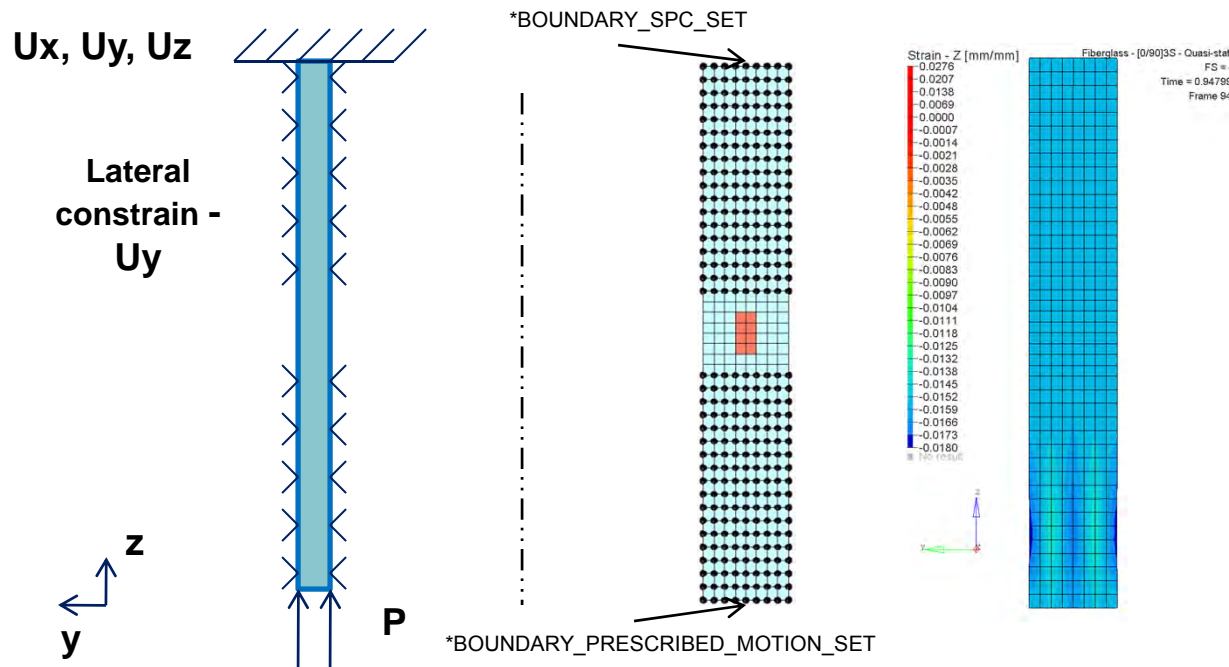

Fiberglass - $[0/90]_{3S}$

- **CBA Phase I:**
 - Training seminars on seat modeling techniques (industry/academia)
 - Installation evaluations:
 - HUD installations.
 - Row-to-row configurations.
 - Bulkhead configurations.
- **CBA Phase II:**
 - Establish partnerships/research agreements with industry to study “real world applications” for composite aircraft crashworthiness
 - Coordinate research efforts with other research groups working on experimental and numerical applications
 - Continue coupon and component level numerical model evaluations
 - Study the effect of offset loading in composite and metallic structures
 - Develop validation methods similar to AC 20-146
 - Training seminars on structural crashworthiness modeling techniques (industry/academia)