

# **Effect of Surface Contamination on Composite Bond Integrity and Durability**

*Gabriela Gutierrez-Duran & Dwayne McDaniel*

JAMS 2018 Technical Review  
May 23-24, 2016

# Effect of Surface Contamination on Composite Bond Integrity and Durability

- **Motivation and Key Issues**

- Past research has focused on determining/understanding acceptable performance criteria using the initial bond strength of composite bonded systems.
- There is significant interest in assessing the durability of composite bonded joints and the how durability is affected by contamination.

- **Objective**

- Develop a process to evaluate the durability of adhesively bonded composite joints
- Investigate **undesirable bonding conditions** by creating scalable and repeatable weak bonds.
- Investigate a means to mitigate the undesirable conditions via surface preparation methods.
- Support CMH-17 with the inclusion of content for bonded systems

# Effect of Surface Contamination on Composite Bond Integrity and Durability

- **Principal Investigators**

- Dwayne McDaniel, Ben Boesl

- **Students**

- Gabriela Gutierrez-Duran, Brian Hernandez, Julie Dubon, Mauricio Pajon

- **FAA Technical Monitor**

- Ahmet Oztekin

- **Industry Participation**

- Exponent, 3M, Embraer, BTG Labs

# Manufacturing of Bonded Systems

*Fabrication of Laminates*

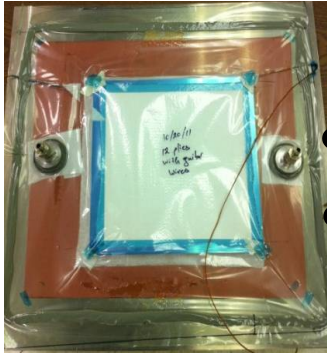

*Laminate Cure*



(Cure Cycle @350F)

*Bonding of Laminates*

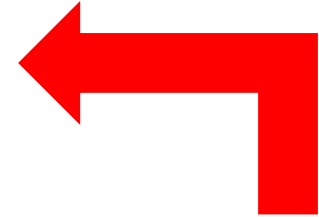

## KEY QUESTION

What happens to bonded joint's strength when contamination occurs, if known can it be mitigated?

*Adhesive Bond Strength Testing*



*Preparing/Cutting Samples*



*Adhesive Cure*



(Cure Cycle @350F)

## CAUSES

Contamination can occur in a manufacturing setting from oil on hands, mold release, leakage/spillage, etc.

# Contamination Approach

**GOAL** - Develop a process to create a scalable and repeatable weak bond via bondline contamination.

Contaminant – Frekote release agent

- Developed a station that can uniformly spray contaminant – vary nozzle size and spray rates
- Potential for creating a scalable weak bond by adjusting concentration of Frekote
- Total amount of contaminate applied is measured using an analysis of pre- and post- weight measurement.

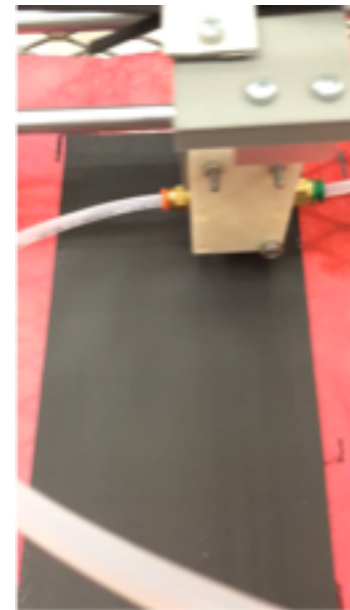

# Bond Quality Evaluation

- Dual Cantilever Beam Testing
  - Measures interlaminar fracture toughness
- Fracture toughness provides a measure of composite strength
  - The critical energy a material may absorb before failure and resistance to delamination
  - $G_{1C} = \frac{3P\delta}{2b(a+|\Delta l|)}$
- Use of MTS machine to measure displacement

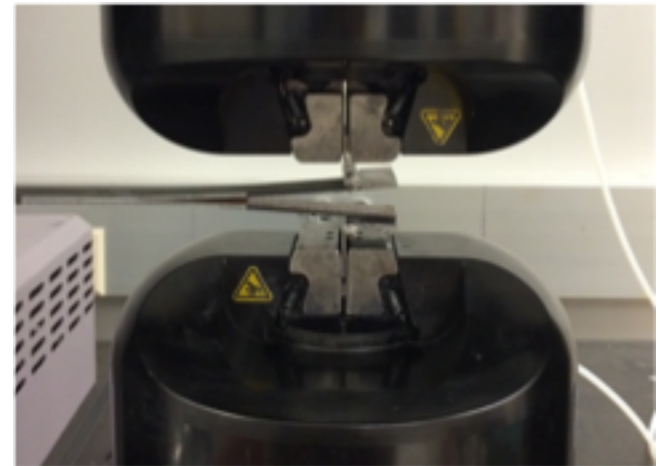
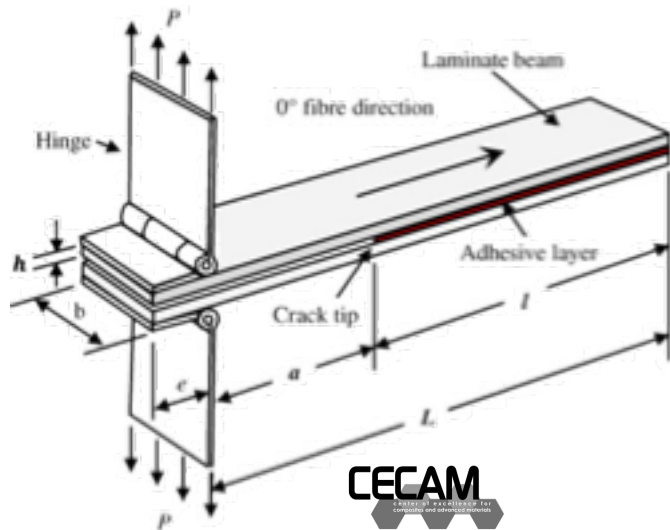
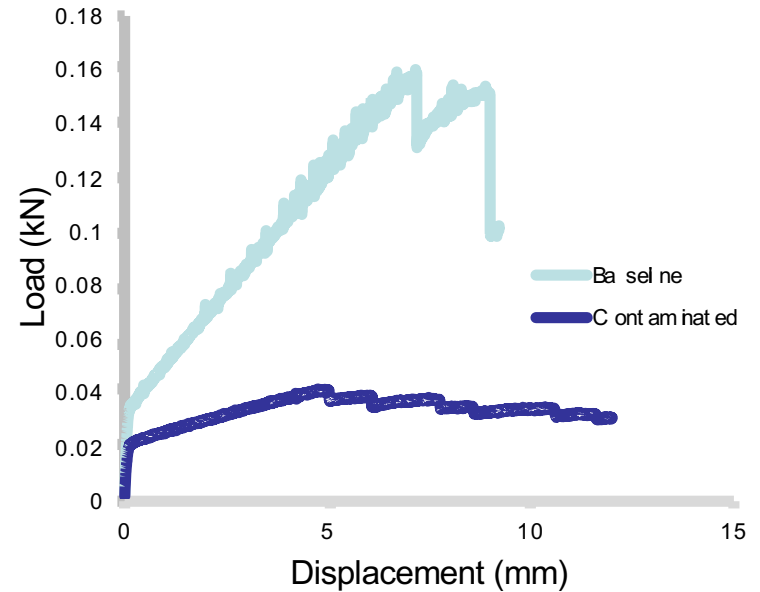

# Materials

- **Material type and curing procedure for specimens:**  
Unidirectional carbon-epoxy system, film adhesive, secondary curing bonding and contaminants.
- **Materials utilized:**
  - Toray P 2362W-19U-304 T800 Unidirectional Prepreg System (350F cure)
  - 3M AF 555 Structural adhesive film (7.5x2 mills, 350F cure)
  - Precision Fabric polyester peel ply 60001
  - Frekote 700-NC from Henkel Corporation

# Calibration of Contamination Levels

- Calibration of the contamination levels is important in order to be able to trace back the amount of contaminant used and relate that amount to the strength of the weak bond created
  - This enables us to determine the different bond strengths that can be created from different amounts of contaminant
- Adjusting spray speeds and mass measurements of the contaminant on a 1” x 1” section of a panel, allows for the determination of the strength of the weak bond
- **Procedures**
  - Modify the spray speed according to the amount of mass desired
    - Fast speeds: less mass
    - Slow speeds: more mass
  - Weigh a 1” x 1” section of a panel before spraying contaminant
  - Spray contaminant and weigh it again
  - Continue process until desired mass is reached



# Contamination Results

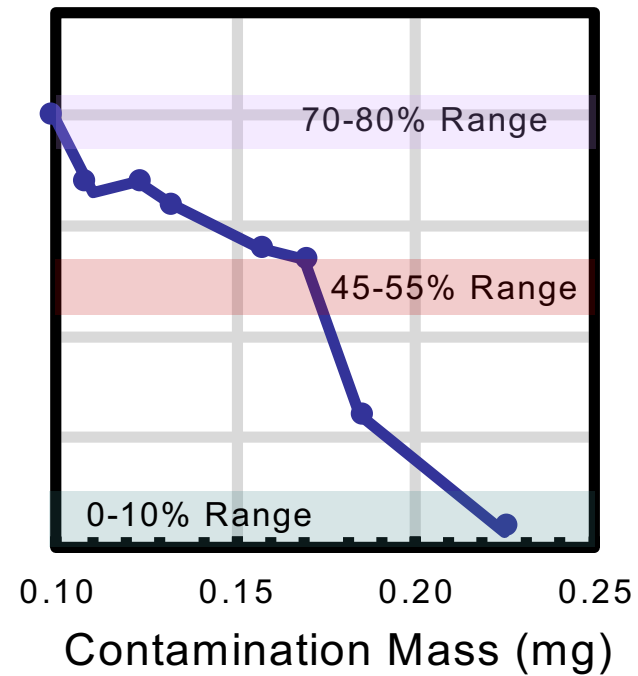
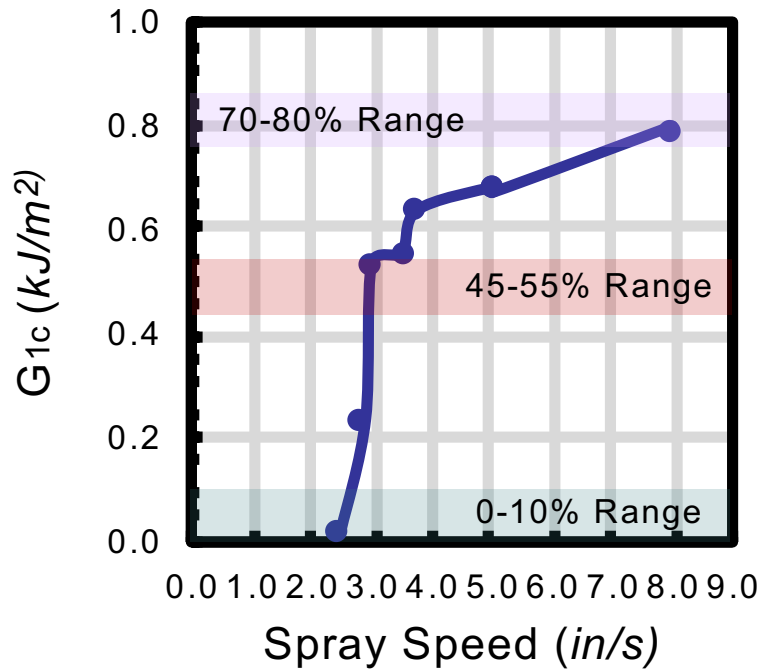

# Mitigation Procedures

- **GOAL** - Develop a process to mitigate the influence of contamination of the bondline
- Two methods of mitigation
  - ***Solvent Wipe*** - Attempt to remove contaminate off of surface with soaked cloth
  - ***Sanding of Material*** - Actively remove material using abrasive

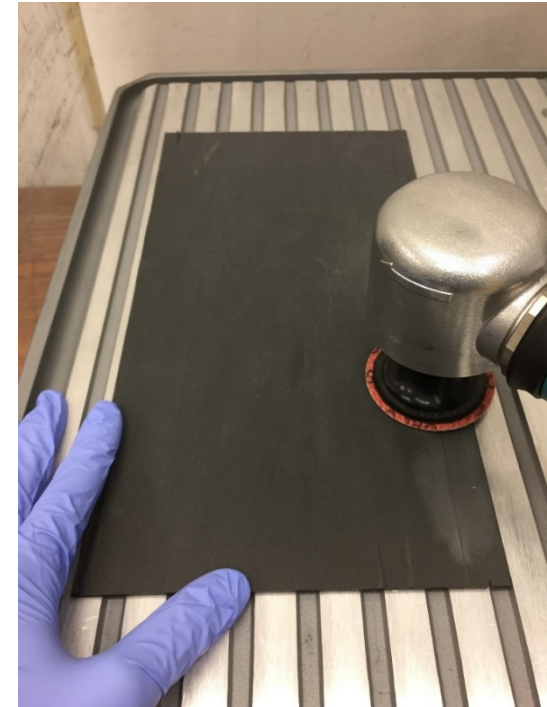
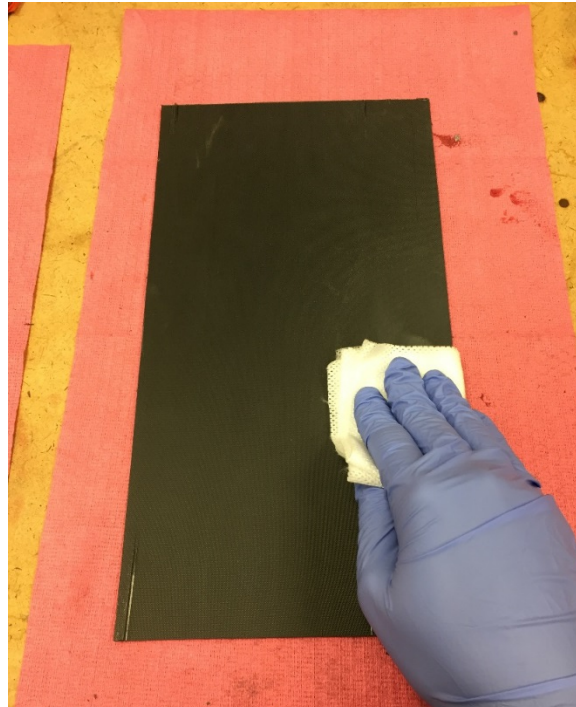

# Results of Mitigation Approaches

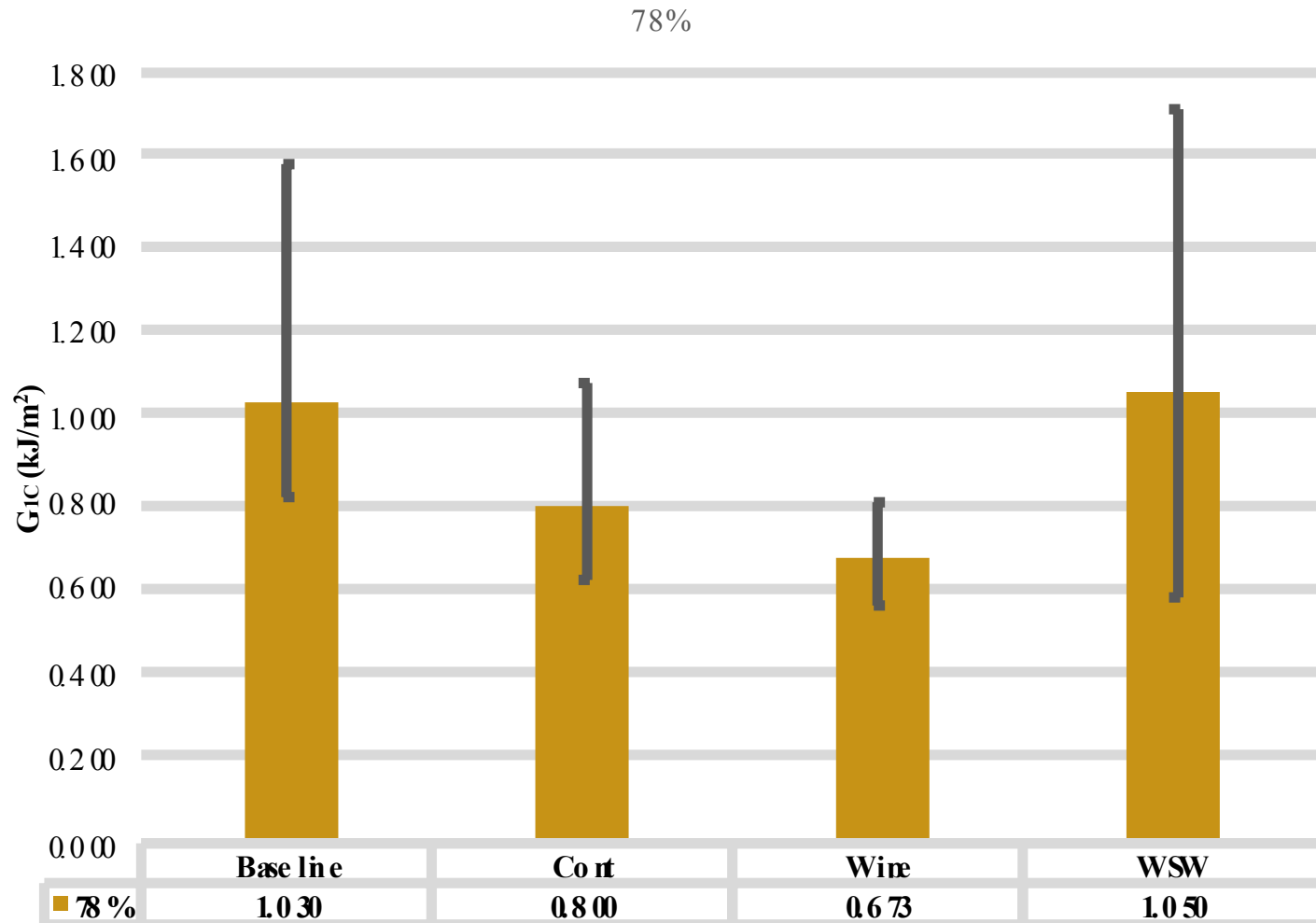

# Mitigation Results

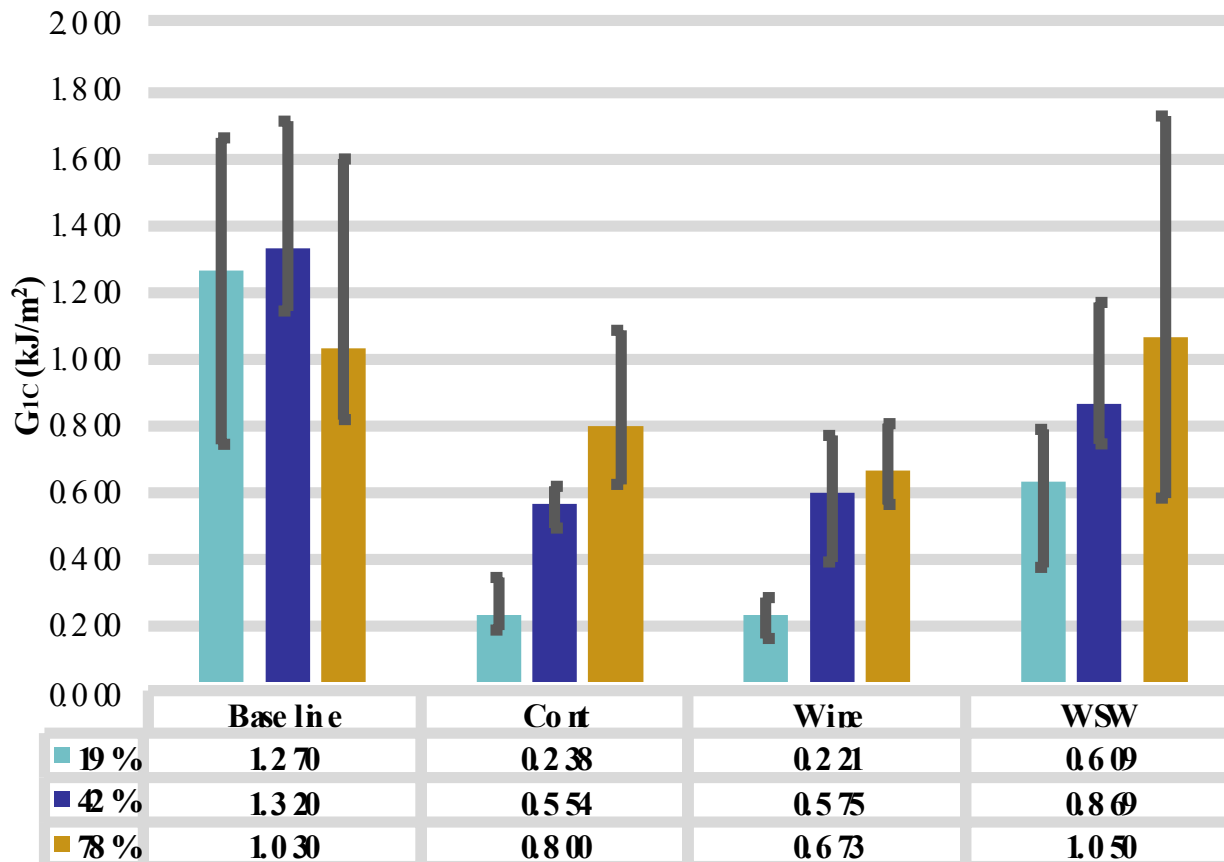

# Failure Modes – 19%

## Mixed-mode failure

Variable combination of interlaminar and cohesion

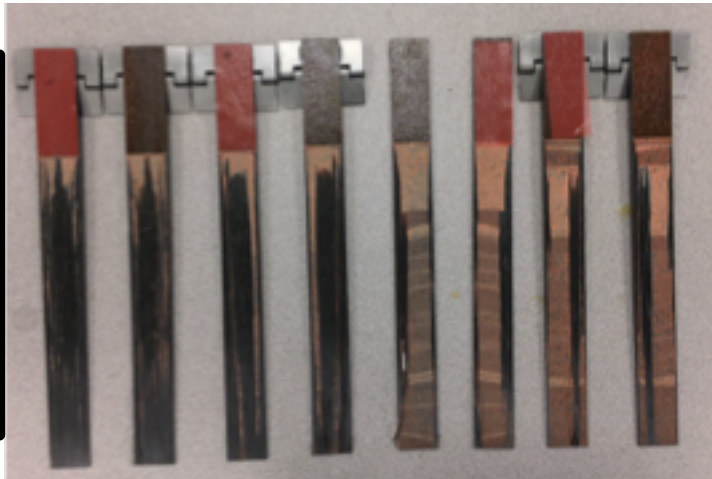

Baseline

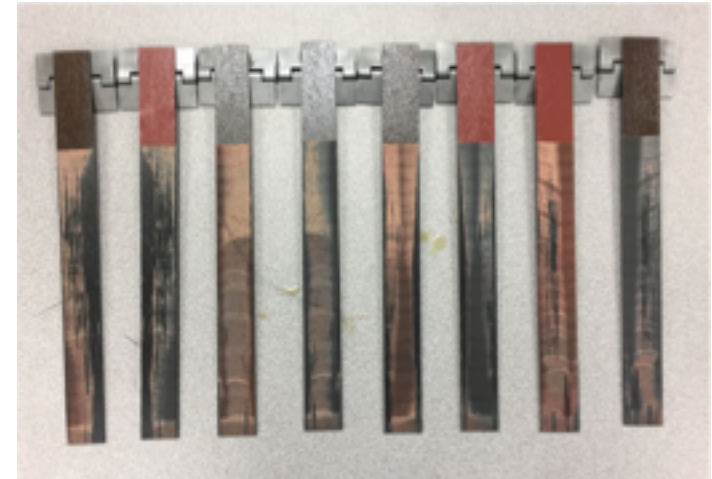

19% Wipe/Sand/Wipe

## Adhesion failure

Separates from the surface of adherent

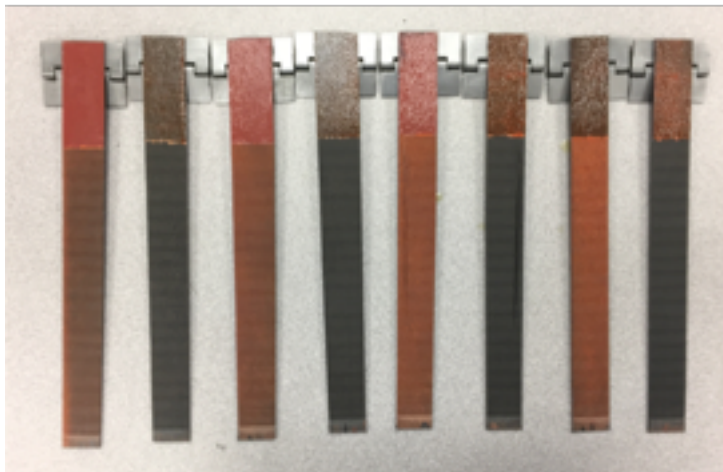

19% Only

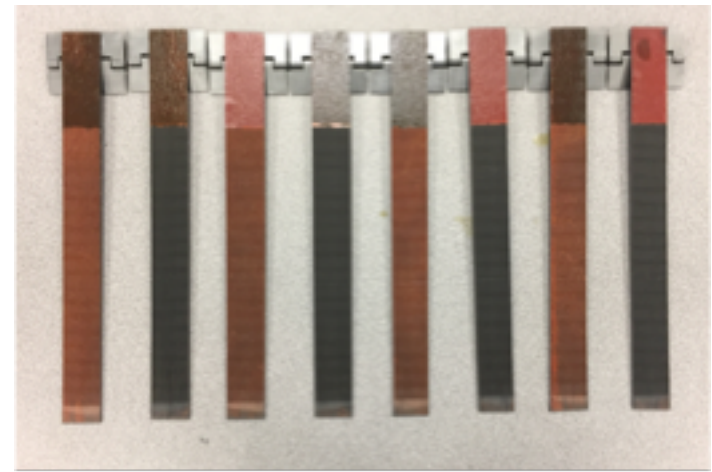

19% Wipe

# Failure Modes – 42%

**Mixed-mode failure**  
Variable combination of interlaminar and cohesion

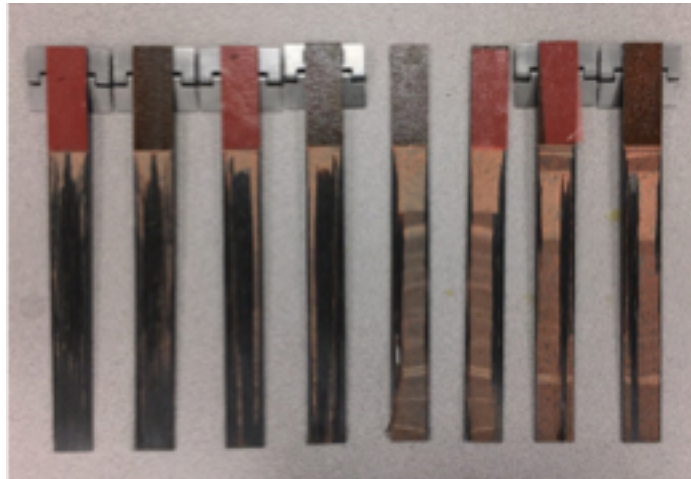

**Baseline**



**42% Wipe/Sand/Wipe**

**Adhesion failure**  
Separates from the surface of adherent

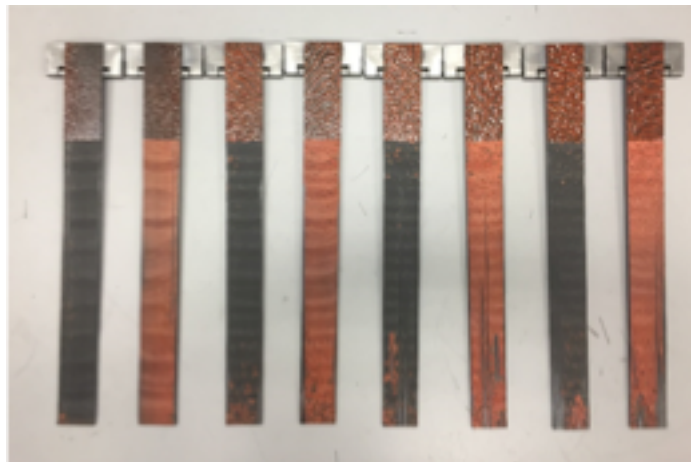

**42% Only**

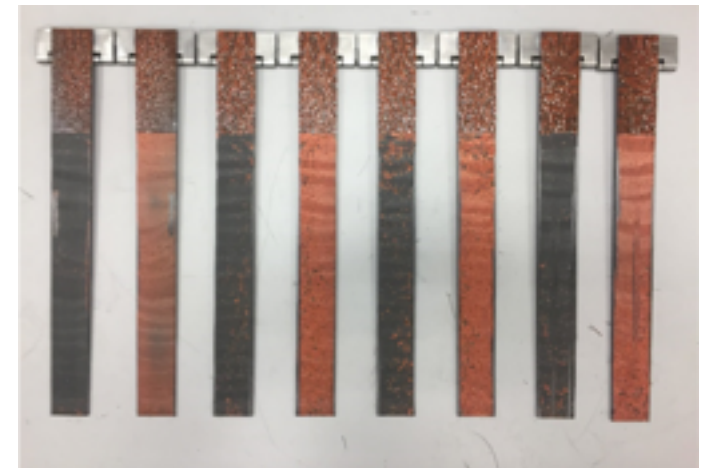

**42% Wipe**

# Failure Modes – 78%

## Mixed-mode failure

Variable combination of interlaminar and cohesion

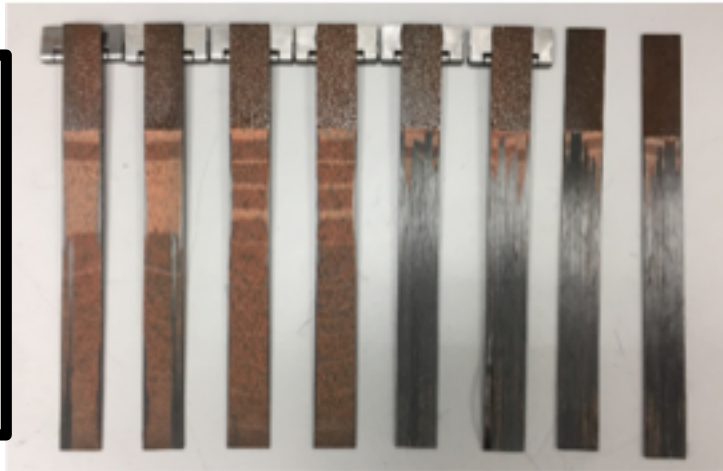

Baseline

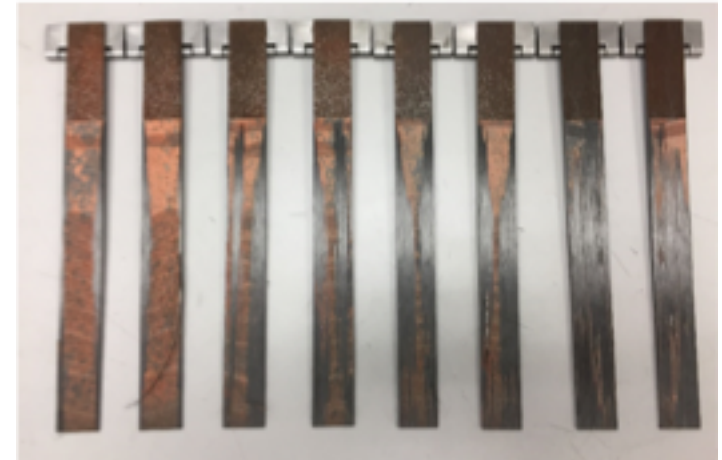

78% Wipe/Sand/Wipe

## Adhesion failure

Separates from the surface of adherent

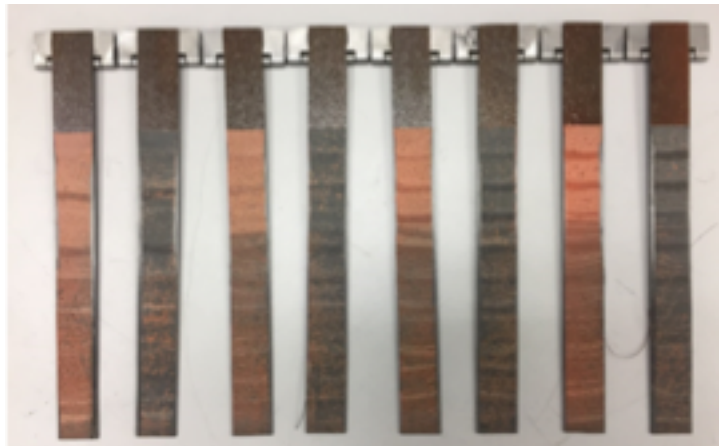

78% Only

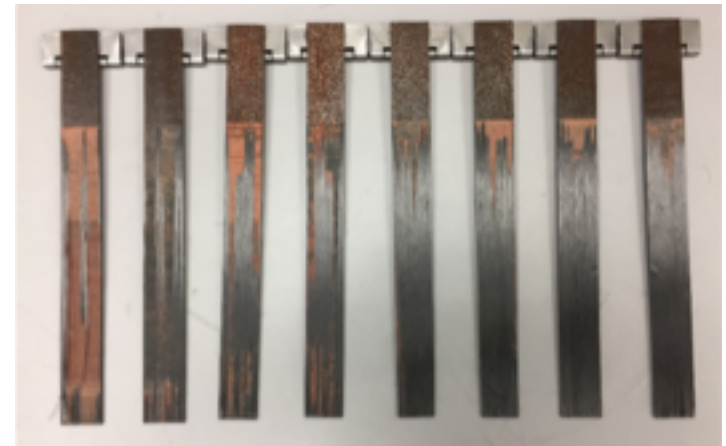

78% Wipe

# In-situ Testing

## Combined Load Frame and Electron Microscopy

### Test Development

#### $\mu$ DCB (Dual Cantilever Beam)

Assess the mechanisms of mode I fracture. Fixture was designed based on literature of metal-adhesive bond testing.

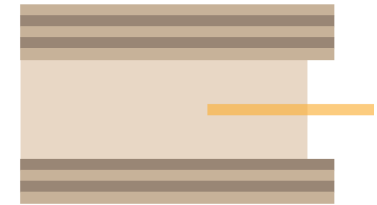
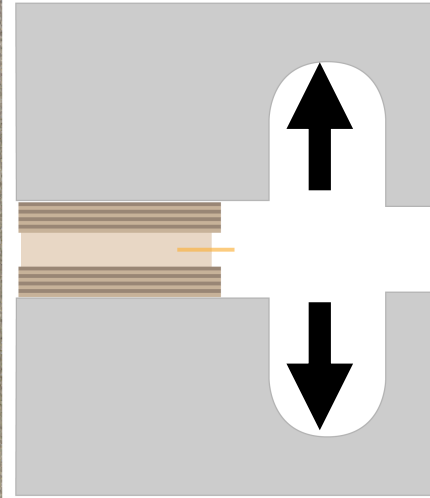
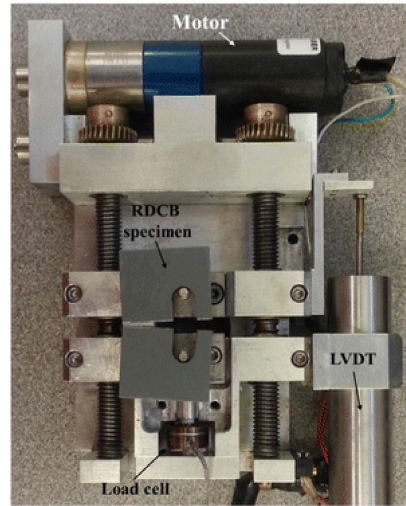

- Unidirectional Composite
- Polymer Adhesive
- Release Ply

#### $\mu$ ENF (End Notch Flexure)

Assesses the mechanisms of mode II fracture. Fixture was designed based of traditional ENF testing of composite bonds

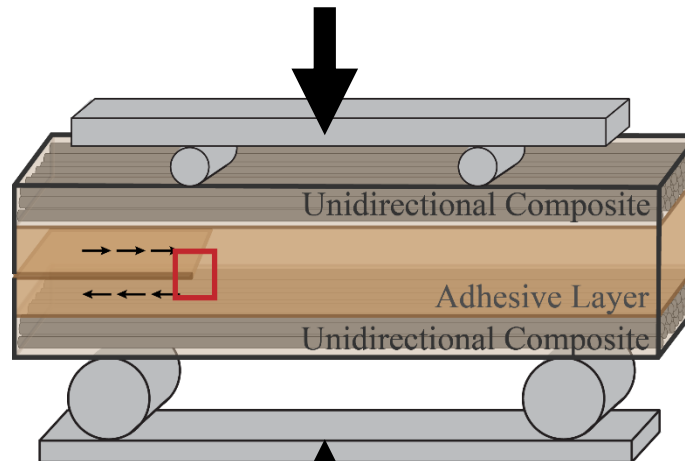

- Unidirectional Composite
- Polymer Adhesive
- Release Ply



# In-situ Testing

## Combined Load Frame and Electron Microscopy

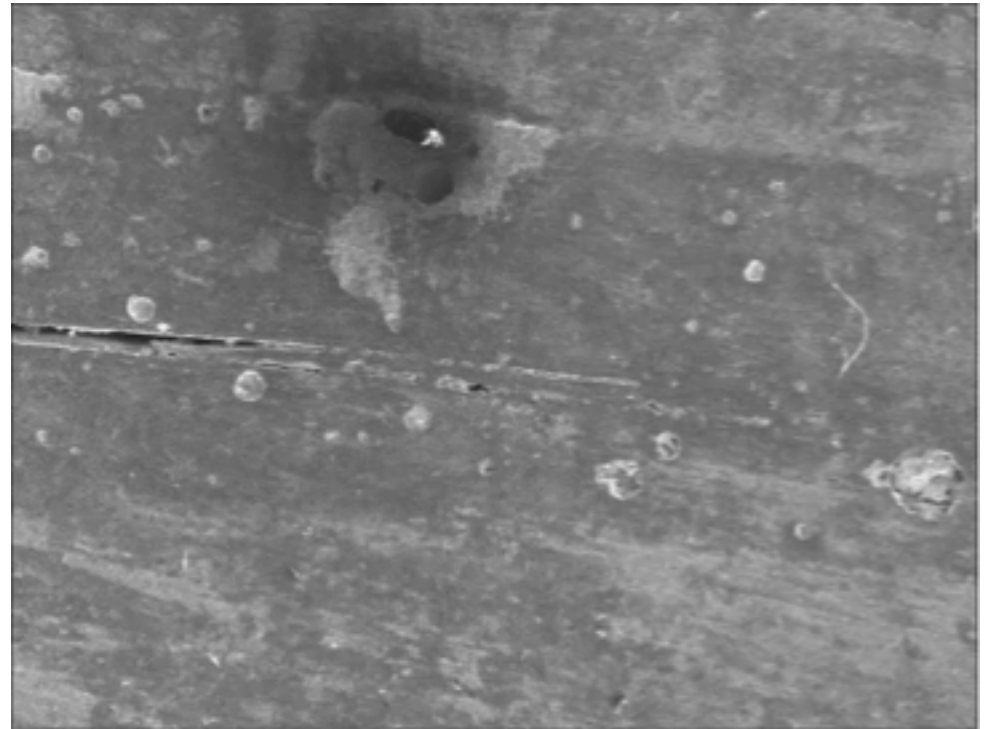
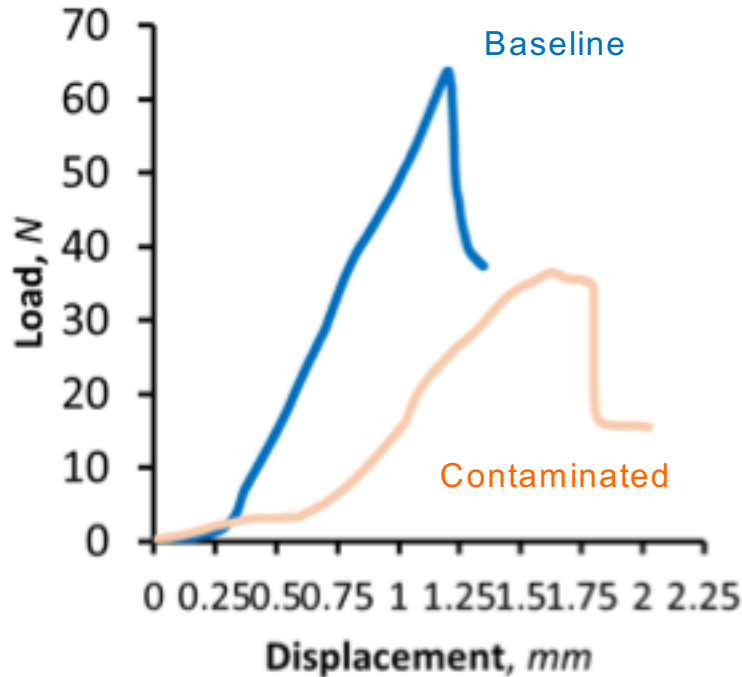

### Specimen Details

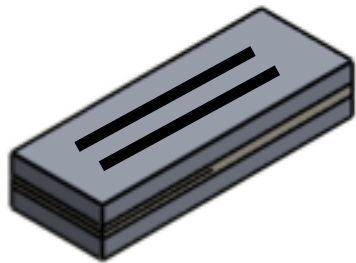

### Baseline

L/W: 40mm x 10mm

thickness: 5.2 mm

Pre-crack: 8 mm

10 layer unidirectional composite panels



### Observations

- Initially bond is very stiff
- Controlled crack propagation begins at ~50N Load
- Unstable crack growth begins at the pre-crack then travels to composite-adhesive interface

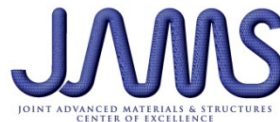

# In-situ Testing

## Combined Load Frame and Electron Microscopy

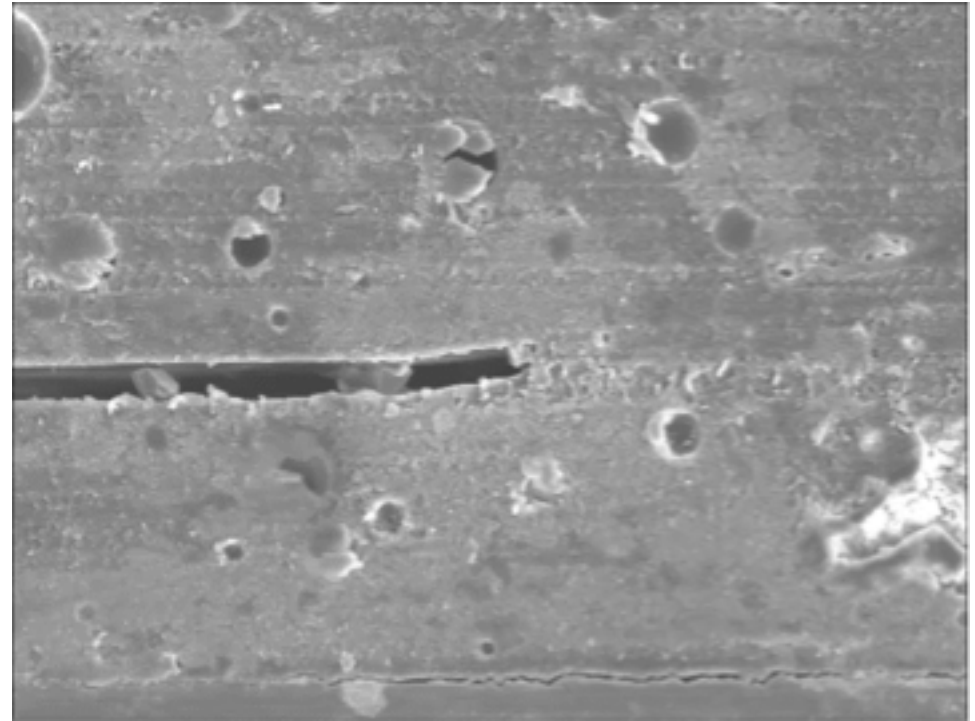
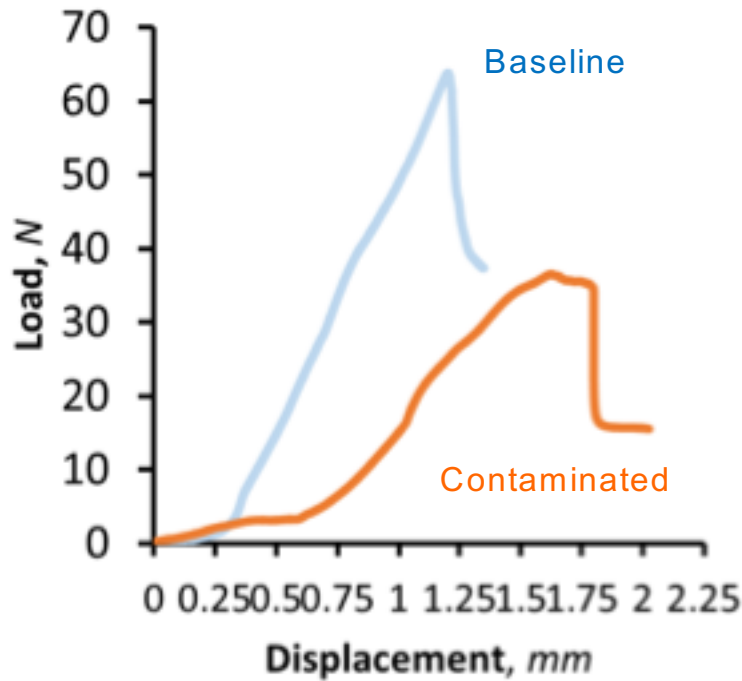

### Specimen Details

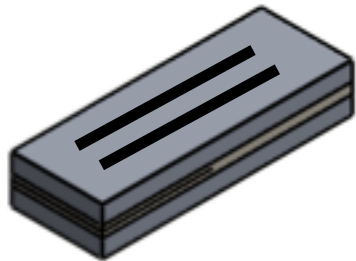

### Contaminated

L/W: 40mm x 10mm

thickness: 5.2 mm

Pre-crack: 8 mm

4% contamination procedure was used at the interface



### Observations

- Initial delamination between adhesive and composite panel
- High compliance during loading, reduction in peak load
- Unstable crack growth begins at the interface and pre-crack remains un-damaged



# In-situ Testing

## Combined Load Frame and Electron Microscopy

### Complications with in situ testing

Small sample sizes and edge effects

Sample testing environment

*At the moment, testing can be used to study mechanisms but not to quantify fracture properties*

From Linear Elastic Fracture Mechanics theory we know the stress field very near the crack tip and from that we can solve for the displacement at any point if  $K_I$  is known.

**Therefore if we know the displacements we can solve for the  $K_I$  value.**

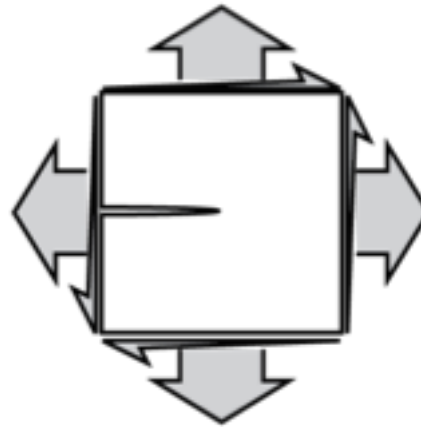

From LEFM

$$\sigma_{xx} = \frac{K_I}{\sqrt{2\pi r}} \cos \frac{1}{2}\theta \left( 1 - \sin \frac{1}{2}\theta \sin \frac{3}{2}\theta \right)$$

$$\sigma_{yy} = \frac{K_I}{\sqrt{2\pi r}} \cos \frac{1}{2}\theta \left( 1 + \sin \frac{1}{2}\theta \sin \frac{3}{2}\theta \right)$$

$$\sigma_{xy} = \frac{K_I}{\sqrt{2\pi r}} \sin \frac{1}{2}\theta \cos \frac{1}{2}\theta \cos \frac{3}{2}\theta$$

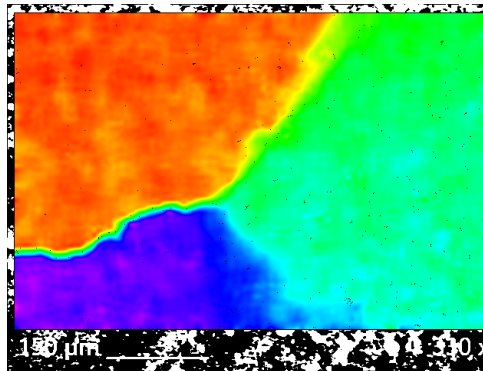

$$u_x = \frac{K_I}{8\mu\pi} \sqrt{2\pi r} \left[ (2\kappa - 1) \cos \frac{\theta}{2} - \cos \frac{3\theta}{2} \right]$$

$$u_y = \frac{K_I}{8\mu\pi} \sqrt{2\pi r} \left[ (2\kappa + 1) \sin \frac{\theta}{2} - \sin \frac{3\theta}{2} \right]$$

# In-situ Testing

## Combined Load Frame and Electron Microscopy

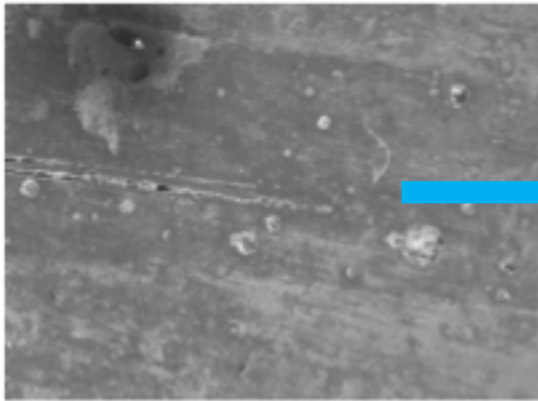

In situ Microscopy

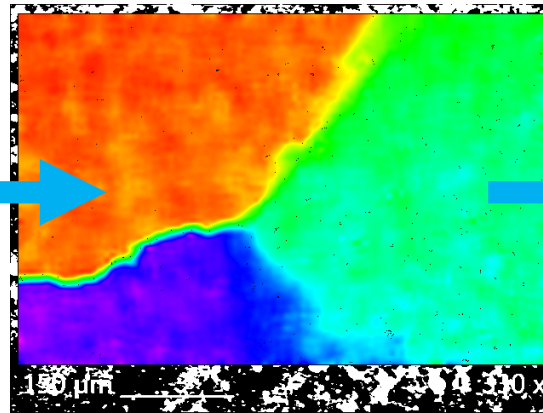

Digital Image Correlation

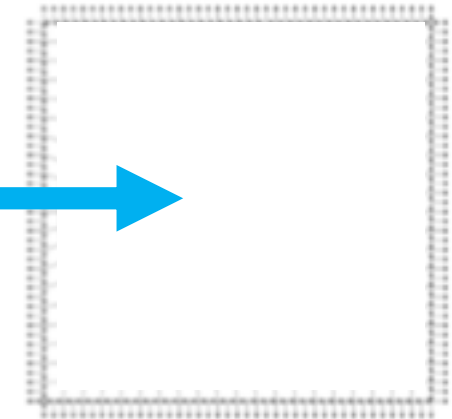

Digitized Displacements

$$u_x = \frac{K_I}{8\mu\pi} \sqrt{2\pi r} \left[ (2\kappa - 1) \cos \frac{\theta}{2} - \cos \frac{3\theta}{2} \right]$$

$$u_y = \frac{K_I}{8\mu\pi} \sqrt{2\pi r} \left[ (2\kappa + 1) \sin \frac{\theta}{2} - \sin \frac{3\theta}{2} \right]$$

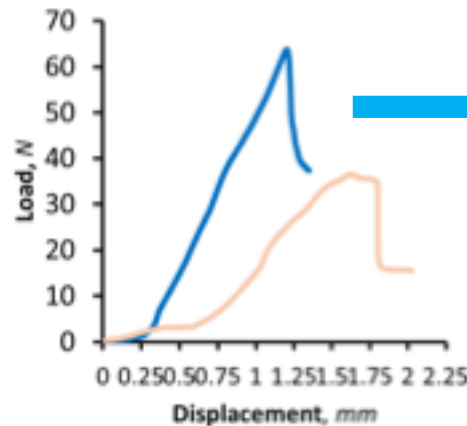

G<sub>IC</sub> for baseline sample

μDCB G<sub>IC</sub> = 0.58 kJ/m<sup>2</sup>

DCB G<sub>IC</sub> = ~1.00 kJ/m<sup>2</sup>

# CMH-17 Support

## Background and Motivation

- A Strategic Composite Plan has been developed by the FAA and has identified three focus areas regarding safety, certification and education. Within these areas, there are a number of initiatives related to structural issues and adhesive bonding.
- As part of the FAA's bonding initiatives, the CMH-17 handbook is supporting the development of content related to bonding design and process guidelines.

## Mission Statement

The Composite Materials Handbook organization creates, publishes and maintains proven, reliable engineering information and standards, subjected to thorough technical review, to support the development and use of composite materials and structures.

# CMH-17 Bonding Process Task Group

## Need for bonding process content in CMH

### The Promise of Bonded Composites

lighter weight, monolithic structures designed with fewer parts and assembled with reduced manufacturing costs (in terms of time and labor)

### The Reality of Bonded Composites

bonded parts that are bolted for confidence, adhesives asked to act as environment seals, challenges of process control to capture and quantify variability

Advantages	Disadvantages
Bonded Joints	
Small stress concentration in adherends; stiff connection; Excellent fatigue properties; No fretting problems; Sealed against corrosion; Smooth surface contour; Relatively lightweight; Damage tolerant	Limits to thickness that can be joined with simple joint configuration; Inspection other than for gross flaws difficult; Prone to environmental degradation; Sensitive to peel and through-thickness stresses; Residual stress problems when joining to metals; Cannot be disassembled; May require costly tooling and facilities; Requires high degree of quality control; May be of environmental concern
Bolted Joints	
Positive connection, low initial risk; Can be disassembled; No thickness limitations; Simple joint configuration; Simple manufacturing process; Simple inspection procedure; Not environmentally sensitive; Provides through-thickness reinforcement; Not sensitive to peel stresses; No major residual stress problem	Considerable stress concentration Prone to fatigue cracking in metallic component; Hole formation can damage composite; Composites's relatively poor bearing properties; Prone to fretting in metal; Prone to corrosion in metal; May require extensive shimming

# CMH-17 Bonding Process Task Group

## Executive Summary

An outline for composite bonding processes was created and circulated for approval. The CMH-17 Bonding Process Task Group used the outline as a framework to create an online forum to capture organize and edit relevant content. The content in the online forum will be converted into draft for circulation, editing and approval.

### Bonding Process Task Group Leadership

Dwayne McDaniel	FIU
Tanila Faria	Embraer
Tim Barry	BTG Labs
Dan Ruffner	Emeritus
Howard Creel	3M

### Bonding Process Task Group Sponsor

Margaret Roylance – M&P

### Bonding Process Task Group Champions

Curt Davies	FAA
Rachael Andrulonis	CMH-17

### Bonding Process Task Group Steering

Nathan Weigand FAA  
Bill Nickerson Navy  
Michelle Johnson LMCO

### Special Thanks to Founding Members

Holly Thomas, Margaret Roylance, Dan Ruffner, Scott Leemans, Carl Rousseau

# CMH-17 Bonding Process Task Group

## Chapter 5 Materials and Processes - The Effect of Variability on Composite Properties

1. Introduction
2. Purpose
3. Scope
4. Constituent Materials
5. Processing of Product Forms
6. Shipping and Storage Processes
7. Construction Processes
8. Cure and Consolidation Processes
- 9. Assembly Processes**
10. Process Control
11. Preparing Material and Processing Specifications

## 5.9 Assembly Processes

### 5.9.1 Fastened Joints

### 5.9.2 Bonded Joints

## 5.9 ASSEMBLY PROCESSES

**Assembly processes are not conventionally covered within composite material characterization, but can have a profound influence on the properties obtained in service. As seen with test coupons, edge and hole quality can dramatically affect the results obtained. While these effects are not usually covered as material properties, it should be noted that there is an engineering trade off between part performance and the time and effort expended toward edge and hole quality. These effects need to be considered along with the base material properties.**



# CMH-17 Support

## CMH17 Volume 3: Materials Usage, Design and Analysis

### Chapter 5 Materials and Processes - The Effects of Variability on Composite Properties

#### Proposal for New Section in Revision H

## 5.9 Assembly Processes

### 5.9.1 Assembly for Bonded Joints

The section covers the process considerations for assembling bonded thermoset composite joints. It represents guidelines drawn from best available knowledge and is not to be used for specification or certification purposes. It is organized to provide the details of the process of secondary bonding, special considerations and advantages of co-curing, and co-bonding processes and considerations for multi-step bond fabrication. The section is focused on load bearing bonds and not on sealants or other adhesive or bonding systems.

#### 5.9.1.1 Introduction

#### 5.9.1.2 General Considerations

- Types of Bonds
- Definitions

#### 5.9.1.3 Secondary Bonding

- General Consideration
- Quality considerations for bonding
- Surface Preparation
- Protecting the Prepared Surface
- Adhesive Application
- Bond Assembly
- Adhesive Cure
- Bond Inspection

#### 5.9.1.4 Co-curing

- Advantages
- Special Considerations

#### 5.9.1.5 Co-bonding

- Advantages
- Special Considerations

#### 5.9.1.6 Multi-Stage Bonding

#### 5.9.1.7 References

### 5.9.2 Assembly for Bolted Joints

### 5.9.3 Assembly for Hybrid Joints

### Five Working Groups Formed for Bonded Joints

- |                                  |                |
|----------------------------------|----------------|
| 1. General Considerations        | Creel, 3M      |
| 2. Surfaces                      | Faria, Embraer |
| 3. Adhesives and Processing      | Creel, 3M      |
| 4. Inspection, Testing, Quality  | McDaniel, FIU  |
| 5. Co-cure, Co-bond, Multi-stage | TBD            |

# CMH-17 Support

Using online forums to organize CMH-17 content



A working compilation of knowledge on surface preparation in the adhesive bonding of composites. Viewers are encouraged to contribute what they know on the subject using the form on the [Contribute Information](#) page.

Other Wiki Pages for CMH 17 Bonding and Adhesives

[Surface Preparation](#) [Co-Curing/Co-bonding/Processing](#) [Testing/Inspection/Quality](#) [Adhesives/Processing](#) [Adhesive & Bond Qualification](#)

# Summary

- A contamination procedure was developed using and Frekote to develop a scalable and repeatable weak bond. The weak bonds can be used to evaluate surface prep techniques and potentially NDI methods.
- Repeatable weakened bonds were obtained using a customized contamination rig for three levels of contamination (~20, 40 and 80% bond strength).
- Mitigation approaches included solvent wiping and solvent wiping/sanding/solvent wiping. Results from these tests indicated that wiping alone did not improve the bond strength, however, there was significant improvement with the wiping/sanding/solvent wiping.
- Means to evaluate mechanisms and initiation of failure via in-situ electron microscopy. Potential methods for quantifying fracture properties.
- An on-line procedure was developed to provide a means for the bonding community to submit content to the CMH-17 handbook. The first draft of the surface prep section was assembled is currently being reviewed.

# Path Forward

- Contaminated DCB coupons and coupons treated with the mitigation methods will be placed in an environmental chamber to determine the effects of contamination on environmental durability.
- Contaminated and treated DCB coupons will be fatigued in a hydraulic fatigue rig that can cyclically load specimens in shear via three point bending. After the specimens have been aged, effects of fatigue on the contaminated specimens will be evaluated.
- Mini-DCB coupons will be developed and tested in the SEM to provide a understanding of the modes of failure. Aspects that can be evaluated include, environmental exposure, contamination and bondline thickness. Efforts will also be made to quantify the fracture toughness using DIC to estimate the strain field around the crack tip.
- Content on bond testing and quality as well as materials will be assembled, organized and submitted for review for CMH-17.

# Questions ?

