

# Standardization of Numerical and Experimental Methods for Composite Crashworthiness – YEAR II

***Paolo Feraboli***

*Aeronautics and Astronautics*

*University of Washington*

*Seattle, WA*



*AMTAS Fall Meeting  
November 2008*

## **Outline**

### **Motivation**

- *Absence of standards and accepted practices in testing and analysis of composites under crash conditions*

### **Benefits to Aviation**

- *Streamline certification process*
- *Increase confidence in analysis methods and therefore level of safety*

### **Objective**

- *Develop experimental and numerical best practices, design guidelines, and test standards*



## **Outline**

### **Approach**

- **Experimental p. 5-14**
  - *Collect and evaluate current test practices*
  - *Develop standard test methods*
- **Numerical p. 15-30**
  - *Collect and evaluate current modeling practices*
  - *Develop improved modeling techniques*
- **Conclusions and Future Work p. 31**





## ***Personnel involved***

### ***Principal Investigator***

- *Dr. Paolo Feraboli*

### ***Students supported***

- *Francesco Deleo (MS/ Ph.D.)*
- *Bonnie Wade (Senior, A&A)*
- *Enrique Galgana (Senior (A&A)*

### ***FAA Technical Monitors***

- *Allan Abramowitz and Curt Davies*

### ***Other FAA Personnel Involved***

- *Dr. Larry Ilcewicz*

### ***Industry Participation***

- *Dr. Mostafa Rassaian (Boeing Phantom Works)*
- *CMH-17 Crashworthiness Working Group*

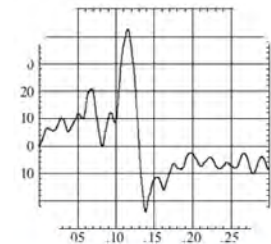

## **Crashworthiness**

### **Experimental Standardization**

- *No existing test standard to determine SEA*
- *No way to screen material systems/ forms/ lay-ups*
- *Material suppliers, OEM's and regulators need to have common ground*
- *Goal is to develop test standard and design guidelines*





***Two current directions in research:***

- *Flat specimen with support fixture*
- *Self-supporting corrugated specimens*
- *Semi-self-supporting tube-derived specimens*
  
- *One material, one lay-up, one process, one molder*
- *Focus on a CMH-17 round robin material*
- *AGATE T700/ 2510 Plain Weave carbon/epoxy*
- *[0/90]<sub>4s</sub>, approx thickness 0.065 in.*
- *Molding performed by TORAY COMP AM (Tacoma, WA)*

## Test specimens

- Add flat and small corner

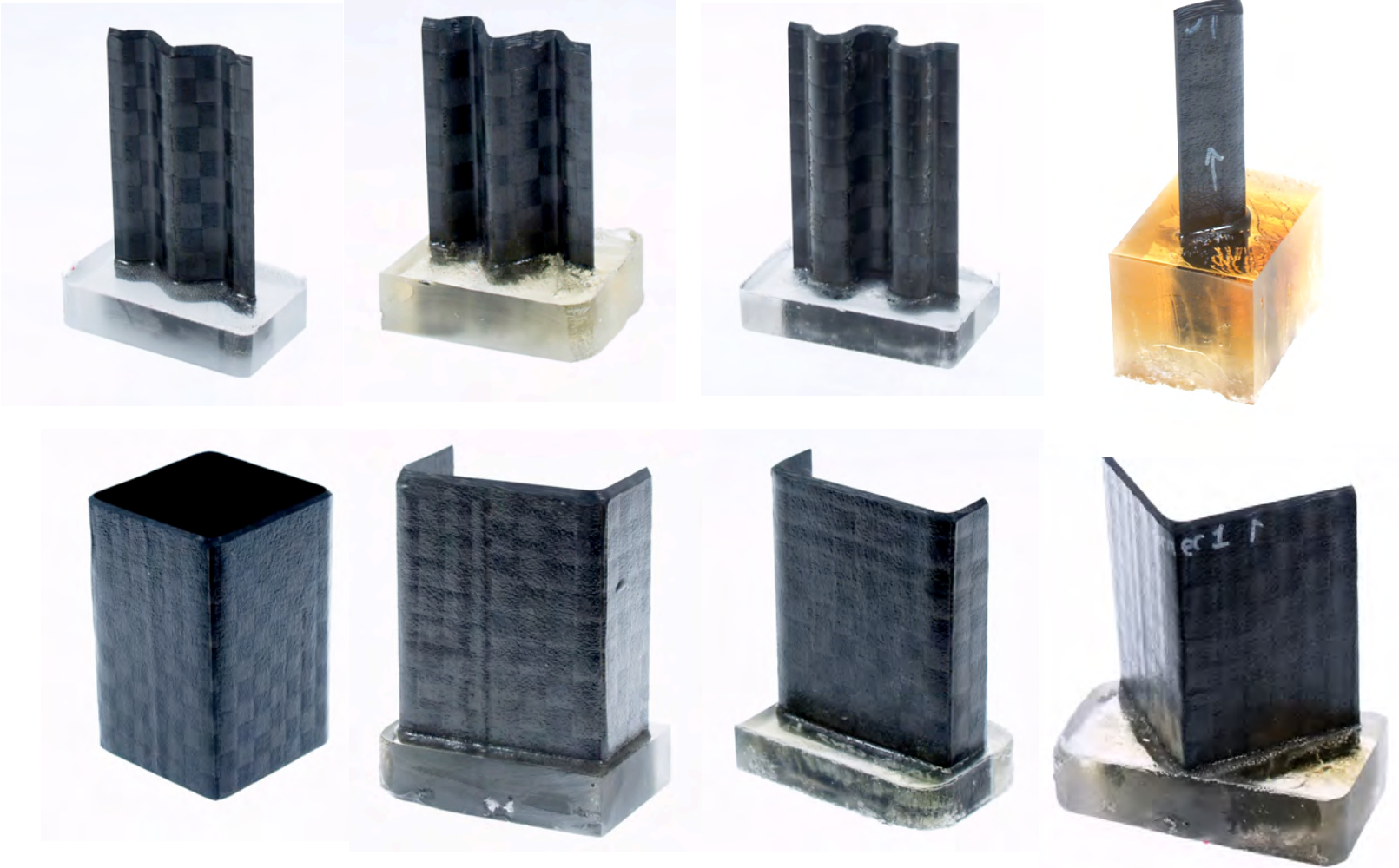



## ***Purpose of study***

- *Identify effect of geometry on SEA*
- *Isolate “real” SEA of flat sections*

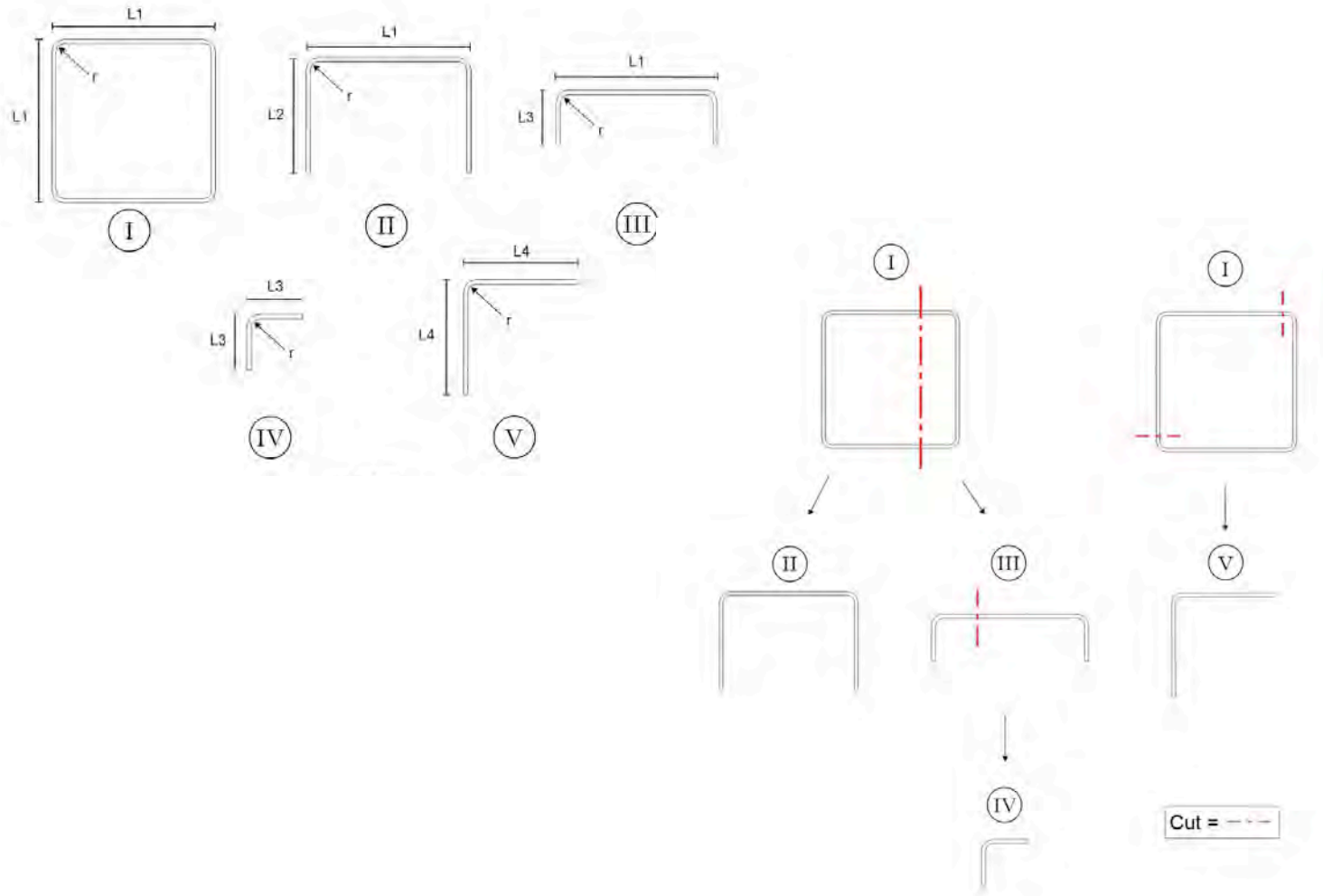



## Results

- Degree of curvature is key to high SEA
- Corrugated specimens (sinusoids) have highest SEA

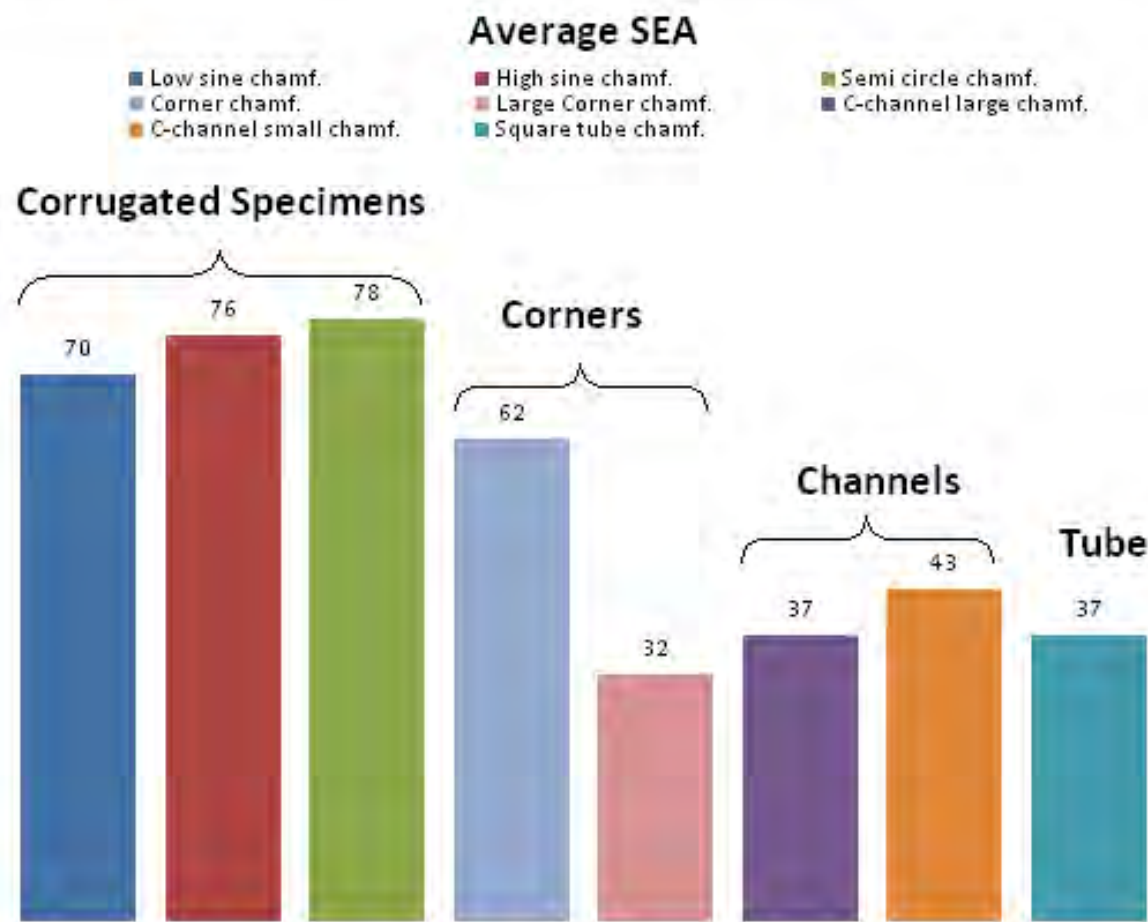

## Effect of curvature

- Use corner specimen as benchmark
- Delta S is the total length of flat segments

$$\frac{SEA_i}{SEA_{IV}} = f(\Delta S)$$

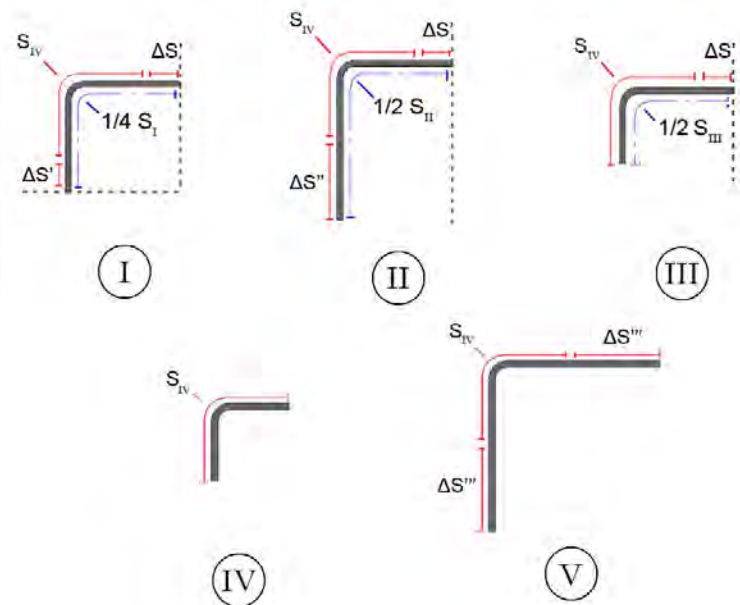
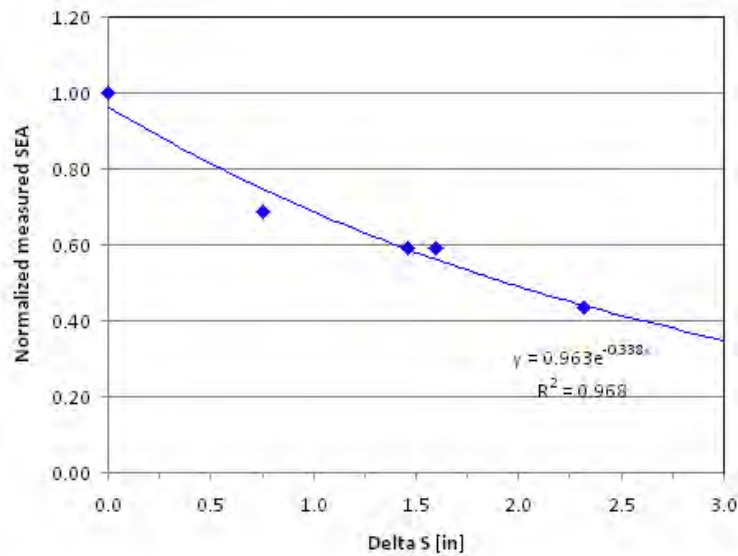

## Flat section SEA

- *In-situ value of SEA for flat segments obtained as difference between corner element and actual specimen SEA*

$$SEA_i = \left( \frac{S_D}{S_i} \right) SEA_D + \left( \frac{\Delta S}{S_i} \right) SEA_f$$

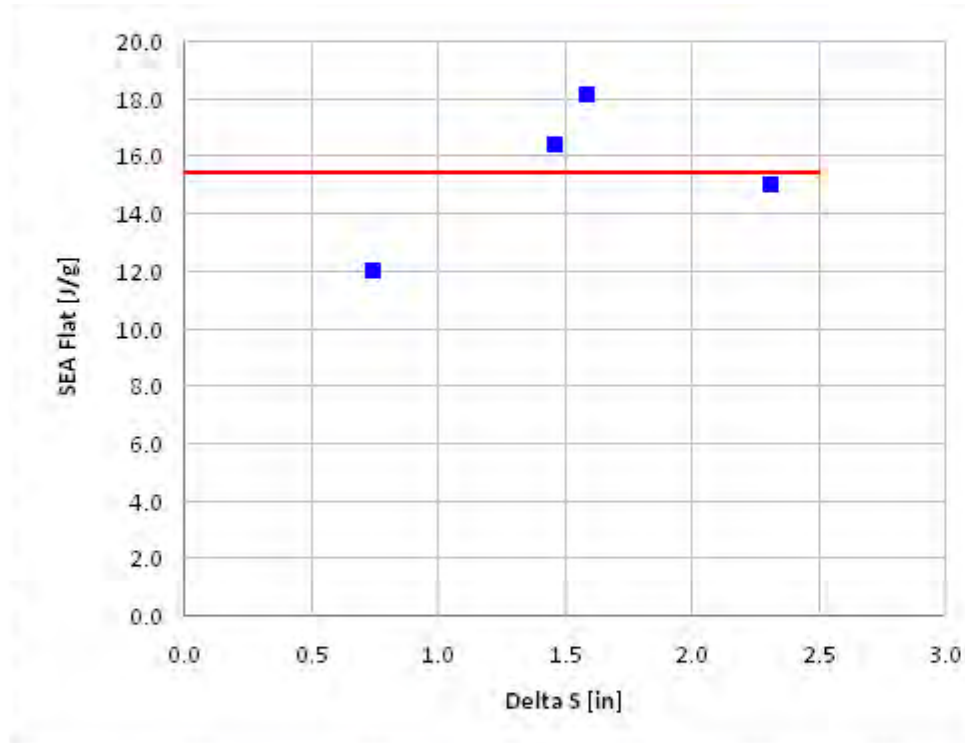

## ***Modified Fixture (UW)***

- *Based on NASA and Engenuity fixtures*
- *Saw-tooth trigger works best*

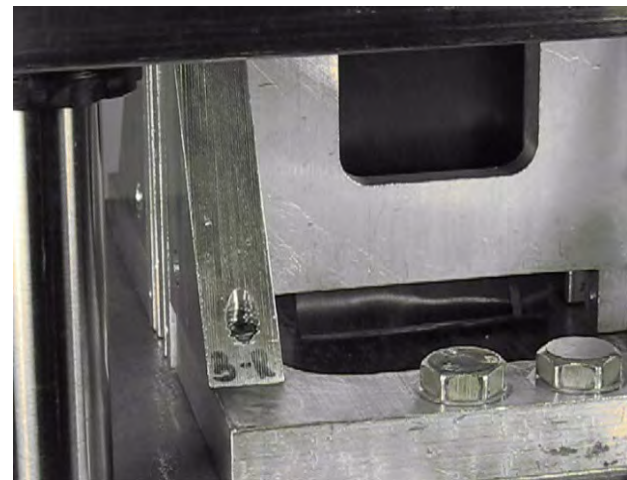
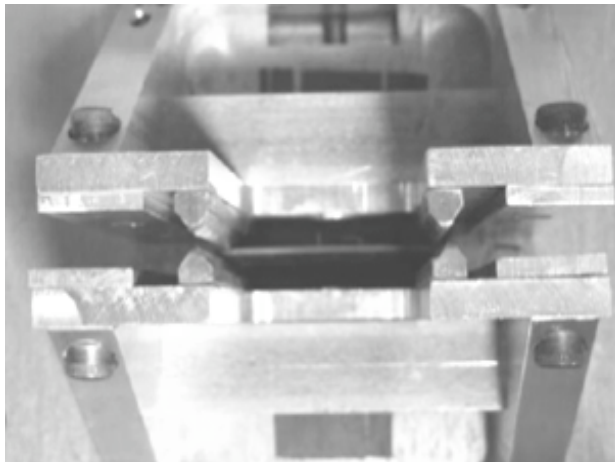
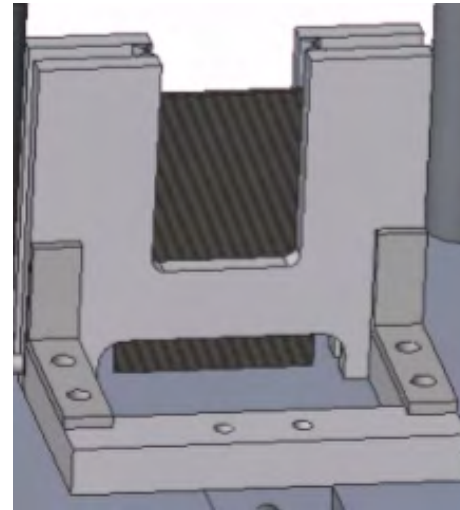
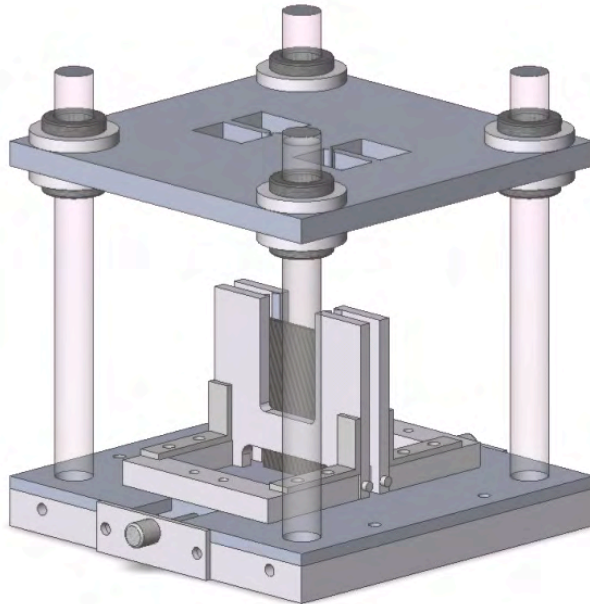

## Modified Fixture (UW)

- Focus on a CMH-17 round robin material
- AGATE T700/ 2510 Plain Weave carbon/epoxy (Torayca)

Sustained crushing – free to deform  
(constant SEA)

Fully  
constrained  
(NASA)

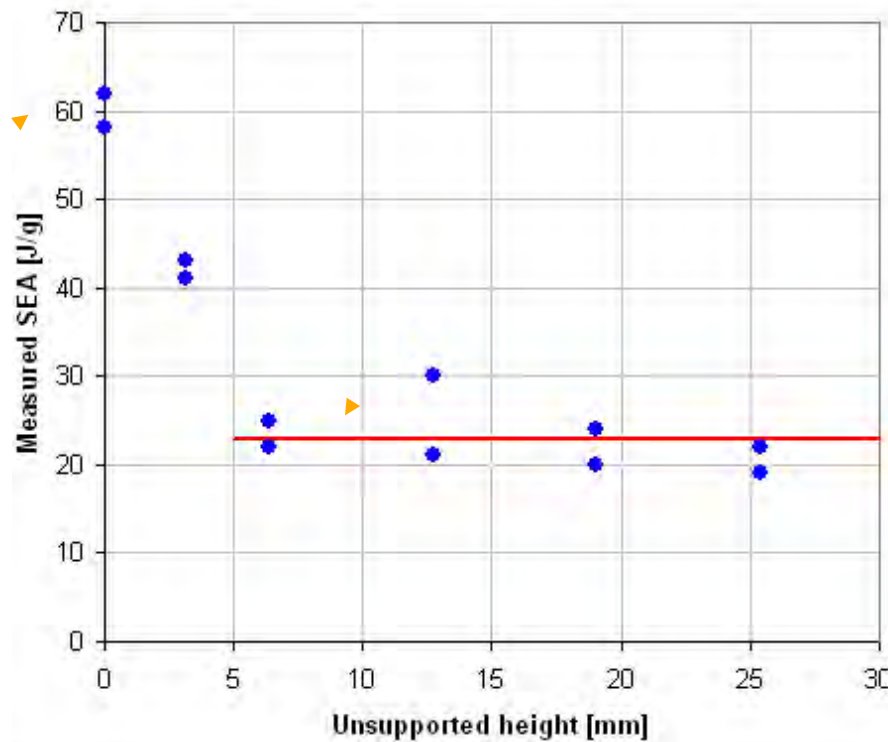

Avg SEA flat: 22 exp. vs. in-situ 17 J/g



## ***Status to date on Experimental Standardization***

- *Flat sections and specimens yield SEA values much lower than specimens with contoured geometries*
- *Fixture poses several questions*
  - *Unknown boundary condition effects*
  - *Variable unsupported height effects*
  - *Difficulties for dynamic testing*
  - *Not all the relevant failure mechanisms may be captured*
- *Need to develop two separate test standards:*
  - *Flat specimen (with fixture)*
  - *Contoured specimen (corner or semicircle)*





## **Crashworthiness**

- **Numerical standardization**
  - *Current FE modeling strategies are not predictive because of the presence of several calibration parameters*
  - *Round Robin initiated involving major FE explicit codes to assess suitability of modeling strategies*
  - *Goal is to develop guidelines for best analysis practices*





## ***Numerical Standardization***

- *Non-linear, dynamic simulation requires explicit FEA codes*
- *Common commercial codes used in this field are:*
  - *LS-DYNA (LSTC)*
  - *ABAQUS Explicit (SIMULIA)*
  - *PAM-CRASH (ESI)*
  - *RADIOSS (ALTAIR)*
  - *NASTRAN-DYTRAN (MSC)*
- *Each code is unique for:*
  - *Material models*
    - *Failure criteria implementation*
    - *Strength and stiffness degradation strategies*
  - *Other code parameters*
    - *contact definition*
    - *damping, time steps, etc...*





## **CMH-17 Numerical round-robin**

- **LSTC LS-DYNA:**
  - *Xinran Xiao (MAT58) – General Motors*
  - *Mostafa Rassaian (MAT54 and 58) – Boeing*
  - *Rich Foedinger (MAT162) – MSC Corp.*
  - *Paolo Feraboli (MAT54) – Univ. Washington*
- **ABAQUS EXPLICIT:**
  - *Kyle Indermuehle (VUMAT fabric) – Simulia*
  - *Graham Barnes (C-zone) – Engenuity*
- **ALTAIR RADIOSS:**
  - *Jean-Baptiste Mouillet – Altair*
  - *Ari Caliskan – Ford*
- **ESI PAM-CRASH:**
  - *Anthony Pickett – ESI Germany* ◀ *withdrawn*
  - *Alastair Johnson – DLR*



## ***CMH-17 Numerical round-robin***

- *Round robin initiated to evaluate the effectiveness and robustness of equivalent numerical models using a common, predefined target structure.*
- *First round: Corrugated specimen*
- *Second round: C-channel*

## ***Modelling strategies with LS-DYNA***

- *LS-DYNA traditionally considered benchmark for crashworthiness*
- *Composite constitutive models are continuum mechanics models - treat as orthotropic linear elastic materials within a failure surface*
- *Failure criterion varies*
- *Beyond failure, elastic properties follow degradation laws:*
  - *progressive failure models (PFM)*
  - *continuum damage mechanics (CDM) models.*
  
- *Progressive failure models: e.g. LS-DYNA MAT54*
- *Damage Mechanics models: e.g LS-DYNA MAT58, ABAQUS Explicit VUMAT Fabric*
  
- *Empirical models: ABAQUS C-Zone*



# Overview of analysis

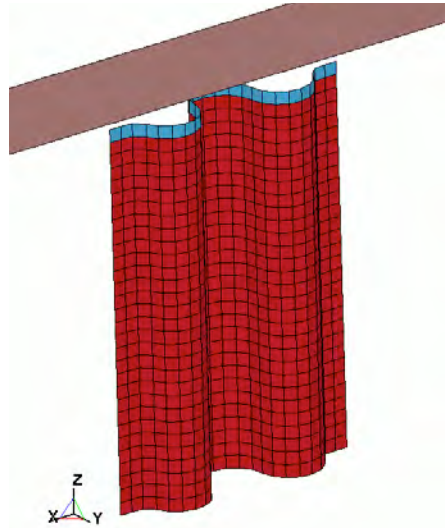

- Corrugated specimen crushing
  - 2.0 in. wide x 3.0 in. tall.
  - 0.1 in. element size.
  - Thinner row used to simulate trigger
  - Base nodes are pinned (fixed translations, free rotations)
  - Constant velocity = 150 in/sec (12.5 fps)
  - Impact with rigid wall
  - 900 elements

| Laminate | Ex [Msi] | Ey [Msi] | vxy   | Gxy [Msi] |
|----------|----------|----------|-------|-----------|
| [0/90]3s | 9.86     | 9.86     | 0.038 | 0.61      |

## \*MAT\_054 (ENHANCED\_COMPOSITE\_DAMAGE)

|              |             |             |             |              |              |               |               |
|--------------|-------------|-------------|-------------|--------------|--------------|---------------|---------------|
| <b>mid</b>   | <b>ro</b>   | <b>ea</b>   | <b>eb</b>   | <b>(ec)</b>  | <b>prba</b>  | <b>(prca)</b> | <b>(prcb)</b> |
| 1            | 1.50E-04    | 8.11E+06    | 7.89E+06    | 1.00E+00     | 0.043        | 0             | 0             |
| <b>gab</b>   | <b>gbc</b>  | <b>gca</b>  | <b>(kf)</b> | <b>aopt</b>  |              |               |               |
| 6.09E+05     | 6.09E+05    | 6.09E+05    | 0           | 3            |              |               |               |
| <b>xp</b>    | <b>yp</b>   | <b>zp</b>   | <b>a1</b>   | <b>a2</b>    | <b>a3</b>    | <b>mangle</b> |               |
| 0            | 0           | 0           | 0           | 0            | 0            | 90            |               |
| <b>v1</b>    | <b>v2</b>   | <b>v3</b>   | <b>d1</b>   | <b>d2</b>    | <b>d3</b>    | <b>dfailm</b> | <b>dfails</b> |
| 0            | 0           | 1           | 0           | 0            | 0            | 0.013         | 0.03          |
| <b>tfail</b> | <b>alph</b> | <b>soft</b> | <b>fbrt</b> | <b>ycfac</b> | <b>dfait</b> | <b>dfailc</b> | <b>efs</b>    |
| 1.00E-09     | 0.3         | 0.5         | 0.95        | 1.2          | 0.02         | -0.013        | 0             |
| <b>xc</b>    | <b>xt</b>   | <b>yc</b>   | <b>yt</b>   | <b>sc</b>    | <b>crit</b>  | <b>beta</b>   |               |
| 1.03E+05     | 1.32E+05    | 1.40E+05    | 1.12E+05    | 1.90E+04     | 54           | 0.5           |               |

## ***MAT54 Enhanced composite damage***

- *Material failure modeled using Chang/Chang criterion.*
- *Each time step, plies of the MAT54 (composite) elements are checked and modified using “progressive damage”. Once all plies have failed element is deleted*
- *Need only traditional ply strength values*
- *Need 10 additional parameters for failure*

For the tensile fiber mode (where “a” is fiber direction and “b” is transverse):

$$\sigma_{aa} > 0 \quad \text{then} \quad e_f^2 = \left( \frac{\sigma_{aa}}{X_t} \right)^2 + \beta \left( \frac{\sigma_{ab}}{S_c} \right)^2 - 1 \begin{cases} \geq 0 & \text{failed} \\ < 0 & \text{elastic} \end{cases}$$

For the compressive fiber mode:

$$\sigma_{aa} < 0 \quad \text{then} \quad e_c^2 = \left( \frac{\sigma_{aa}}{X_c} \right)^2 - 1 \begin{cases} \geq 0 & \text{failed} \\ < 0 & \text{elastic} \end{cases}$$

For the tensile matrix mode:

$$\sigma_{bb} > 0 \quad \text{then} \quad e_m^2 = \left( \frac{\sigma_{bb}}{Y_t} \right)^2 + \left( \frac{\sigma_{ab}}{S_c} \right)^2 - 1 \begin{cases} \geq 0 & \text{failed} \\ < 0 & \text{elastic} \end{cases}$$

For the compressive matrix mode:

$$\sigma_{bb} < 0 \quad \text{then} \quad e_d^2 = \left( \frac{\sigma_{bb}}{2S_c} \right)^2 + \left[ \left( \frac{Y_c}{2S_c} \right)^2 - 1 \right] \frac{\sigma_{bb}}{Y_c} + \left( \frac{\sigma_{ab}}{S_c} \right)^2 - 1 \begin{cases} \geq 0 & \text{failed} \\ < 0 & \text{elastic} \end{cases}$$

## Parameters

- **DFAILM**. Maximum strain for matrix straining in tension or compression (active only if  $DFAILT > 0$ ). The layer in the element is completely removed after the maximum strain in the matrix direction is reached.
- **DFAILS**. Maximum shear strain (active only if  $DFAILT > 0$ ). The layer in the element is completely removed after the maximum shear strain is reached. The input value is always positive.
- **TFAIL**. Time step criteria for element deletion  $0.0 \leq \beta \leq 0.1 \leq \beta \leq 1.0$ .
- **ALPH**. Stress parameter as shown in Equation 5.1.5 and 5.1.6.
- **SOFT**. Softening reduction factor for material strength in crash front elements (default = 1.0).  $TFAIL$  must be greater than zero to activate this option.
- **DFAILT**. Maximum strain for fiber tension. The maximum is 1 = 100% strain. The layer in the element is completely removed after the maximum compressive strain in the fiber direction is reached.
- **DFAILC**. Maximum strain for fiber compression. The maximum is -1 = 100% compression. The layer in the element is completely removed after the maximum compressive strain in the fiber direction is reached.
- **BETA**. Weighting factor for shear term in tensile fiber mode. The range of value is  $0.0 \leq \beta \leq 1.0$ .  $\beta = 0 \rightarrow$  Max Strain Criteria and  $\beta = 1 \rightarrow$  Hashin failure criteria is used
- **EFS**. Effective Failure Strain, which is not the strain at the failure stress. The following figure, Figure 5.2.1, shows an example of the stress versus strain curve used in MAT 54 in this study. If EFS is greater than zero, failure occurs if the effective strain is greater than EFS.





## MAT54 failure rules

- Strain-based failure vs. stress-based failure
- DFAILC vs. XC

if  $\varepsilon_{aa} > DFAILT$  Remove ply

if  $|\varepsilon_{aa}| > |DFAILC|$  Remove ply

if  $|\varepsilon_{bb}| > |DFAILM|$  Remove ply

if  $|\varepsilon_{ab}| > |DFAILS|$  Remove ply



Example Stress-Strain Curve

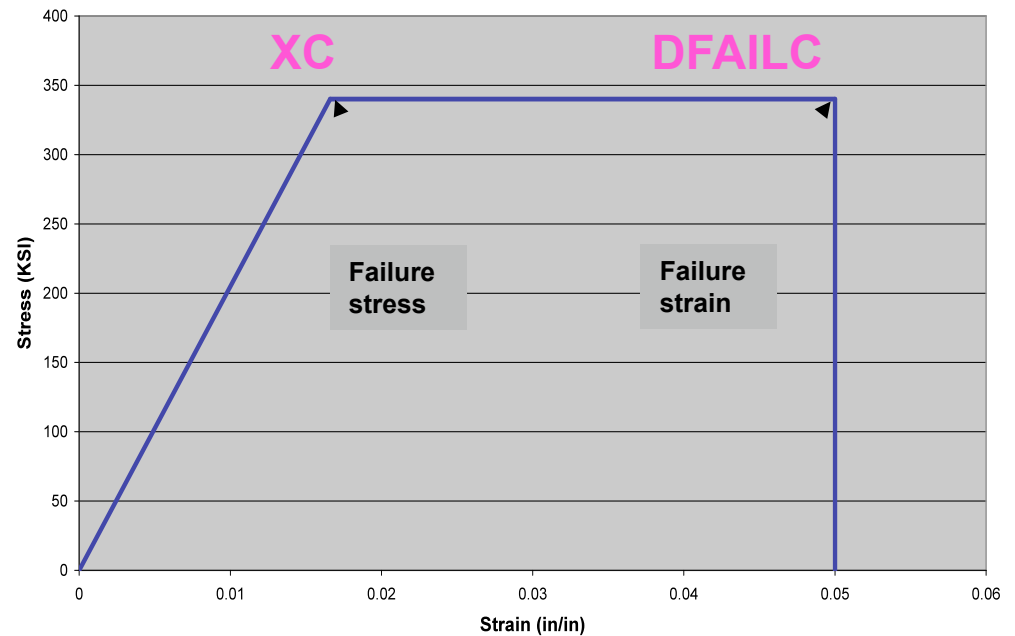

## ***Eerily close accuracy***

- *For each shape it is possible to achieve excellent correlation between experiment and analysis (elastic slope and average crush force)*
- *SEA value within 1%*
- *Results are filtered*
- *Crushing failure mode manifests as element deletion without formation of fragments, fronds*

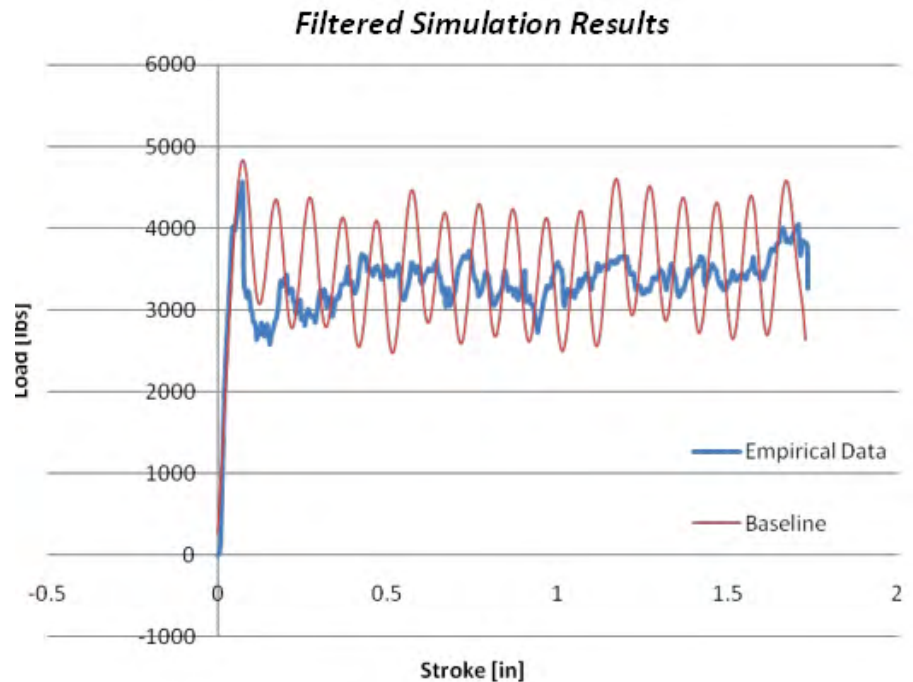
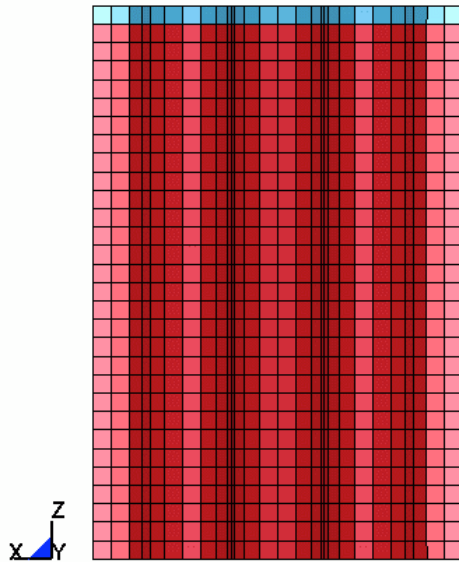

## Two failure modes

- *DESIRABLE: Failure initiates at the crush front and leads to stable L-D curves and progressive element deletion*

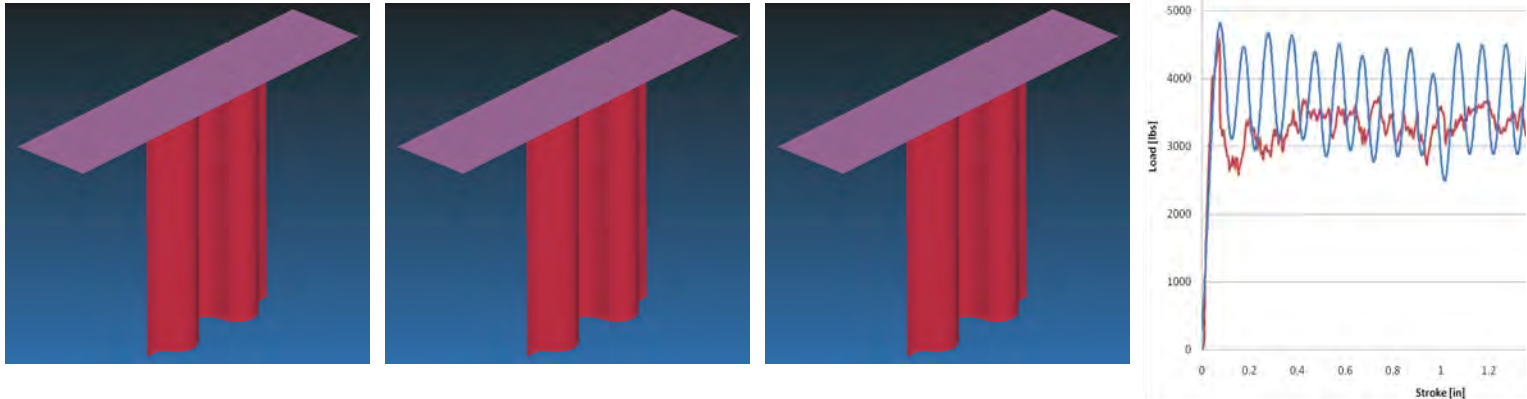

- *UNDESIRABLE: Failure does not initiate at the crush front and strength limit is exceeded away from loading plate - failure leads to unstable L-D curves and specimen buckling*

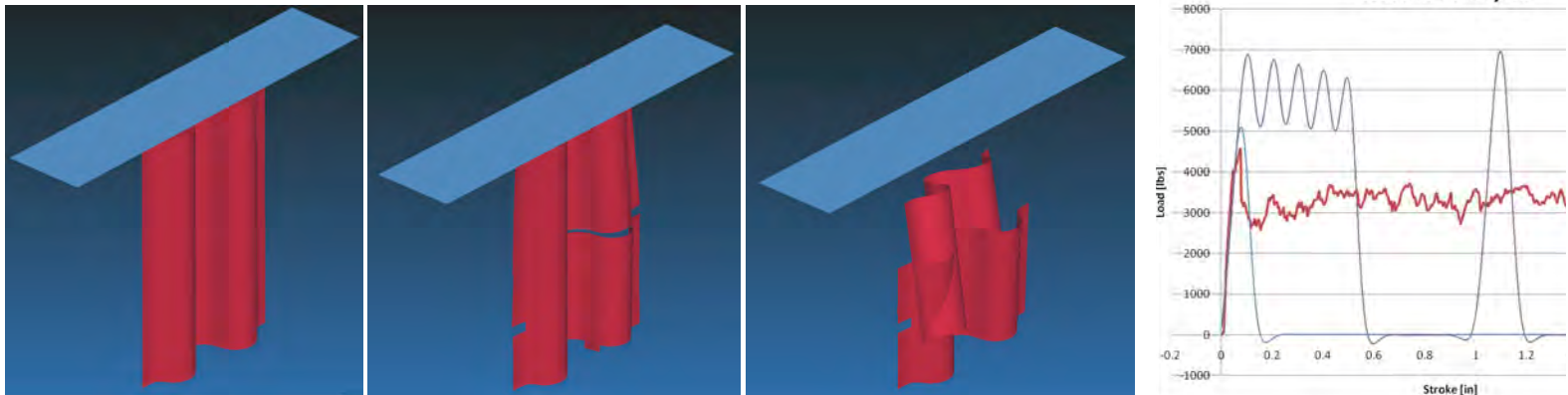

## Parametric investigation

- *Element size, compressive strength, compressive strain-to-failure influence greatly the analysis results*
- *SOFT crush front parameter alone is most influential of all*

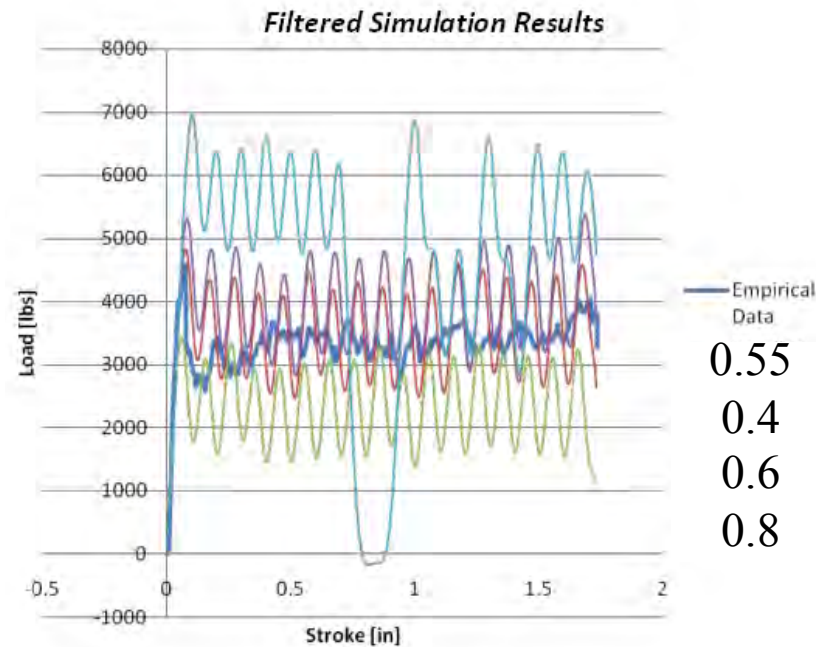

| Case | SEA   | % change w.r.t Baseline | % change w.r.t Test | Crushing Behavior |
|------|-------|-------------------------|---------------------|-------------------|
|      | [J/g] | [-]                     | [-]                 |                   |
| 6_1  | 44.63 | -33.3%                  | -33.7%              | Successful        |
| 6_2  | 75.86 | 13.3%                   | 12.7%               | Successful        |
| 6_3  | 88.56 | 32.3%                   | 31.5%               | Unstable          |

## ***Parametric investigation***

- *SOFT parameter reduces the strength of row of elements following the current crush front in order to facilitate progressive crushing over buckling failure*
  - *High SOFT (e.g. 0.8 = 80%) means that the row immediately behind crush front is assigned 80% of the pristine material strength – this in turn yields higher SEA values*
  - *Low SOFT (e.g. 0.4 = 40%) means that the row immediately behind crush front is assigned 40% of the pristine material strength – this in turn yields lower SEA values*
- *SOFT is a fictitious parameter that introduces a state of “pre-existing damage” in the elements in order to make them weaker, and hence easier to undergo crushing*
- *SOFT parameter values cannot be selected a priori or based on any estimation since it has no direct physical meaning*



## **SEA vs. SOFT**

- *It is found that SOFT parameter does not remain constant among different shapes*
- *This makes certification via analysis supported by test evidence (building block approach) more difficult*
- *To achieve sustained crushing over other failure mechanisms, the SOFT parameter needs to vary for each shape*
- *However, it is found that a relationship exists between SEA and SOFT parameter, which is related to degree of curvature of the specimen*
- *Degree of curvature of the cross section influences stability and hence favors crushing over buckling failure*





## SEA vs. SOFT

- *Linear relationship between SEA and SOFT parameter can be used to generate analysis/ design charts for other shapes*
- *Contoured specimens exhibit highest SEA and have higher SOFT values – they are inherently stable, hence the strength of the element needs not to be reduced significantly in order to crush stably (50-65%)*
- *Specimens with more flatness exhibit lowest SEA and have lower SOFT values – they are prone to instability, hence the strength of the element row needs to be reduced significantly in order to crush stably. (8-25%)*

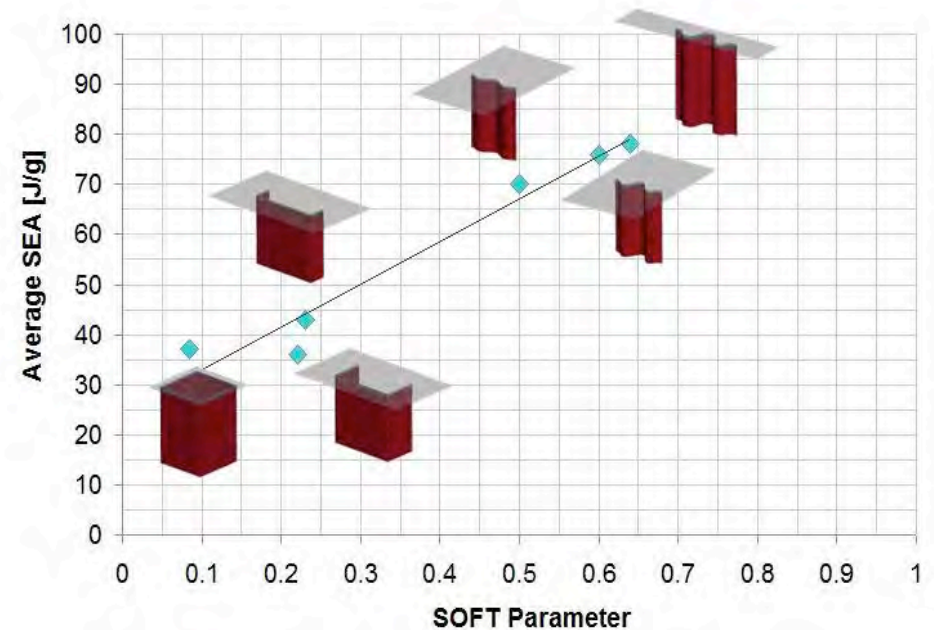





## ***Status to date on Numerical Standardization***

- *Modeling of the crush behavior with MAT54 for all specimens considered has been achieved and it can be shown to be highly successful*
- *MAT54 is a progressive failure model*
  - *Advantages: uses ply-level properties, simple failure criteria, and is fast to run*
  - *Disadvantages: contains several fictitious parameters that cannot be determined experimentally a priori*
- *SOFT parameter needs to be varied based on geometry alone (all other parameters being constant), but it has been shown that it can be consistently related to the degree of curvature of the cross section and hence its relative preference to fail by crushing over buckling*



## ***Conclusions of Year I***

- *The effect of cross section geometry has been shown to have a profound effect on the energy absorption behavior*
- *Self-supporting and flat specimens have been proposed and evaluated*
- *SEA is not a true material property but a structural one*

## ***Future work in Year II***

- *Need to develop two test standards*
- *Perform dynamic crush testing at Boeing Mesa, AZ*
- *Develop LS-DYNA MAT58 and ABAQUS Vumat models*

## ***CMH-17 Handbook***

- *CMH-17 can be an excellent forum for coordinating multi-organizational efforts aimed at standardizing composite analysis and testing*