



JAMS

Development of Reliability-Based Damage Tolerant Structural Design Methodology

Presented to AMTAS Spring 2007 Meeting

Kuen Y. Lin, Andrey Styuart, and Chi Ho Eric Cheung

Department of Aeronautics and Astronautics

University of Washington

April 12, 2007



The Joint Advanced Materials and Structures Center of Excellence

- **Principal Investigator:**
 - Dr. Kuen Y. Lin, Aeronautics and Astronautics, UW
- **Research Scientist:** Dr. Andrey Styuart, UW
- **Research Assistants:** Chi Ho “Eric” Cheung, UW
- **FAA Technical Monitor:** Curtis Davies
- **Other FAA Personnel:** Dr. Larry Ilcewicz
- **Industry Participants:** Dr. Cliff Chen, Dr. Hamid Razi, Mr. Gerald Mabson, Dr. Alan Miller (All from Boeing)

Reliability-Based Damage Tolerant Structural Design Methodology

- **Motivation and Key Issues:** Composite materials are being used in aircraft primary structures such as 787 wings and fuselage. In these applications, stringent requirements on weight, damage tolerance, reliability and cost must be satisfied. Although currently there are MSG-3 guidelines for general aircraft maintenance, an urgent need exists to develop a standardized methodology specifically for composite structures to establish an optimal inspection schedule that provides minimum maintenance cost and maximum structural reliability.
- **Objective:** Develop a probabilistic method for estimating structural component reliabilities suitable for aircraft design, inspection, and regulatory compliance.

Critical Damage Types in Metals vs. Composites

	Fatigue damage, metals	Impact damage, composites
Type of uncertainty	Quite certain: fatigue crack	3-5 damage types should be considered for any particular structure type
Location of uncertainty	Quite certain: high stress concentration locations	All surface: relative damage frequency is known
Size of uncertainty	For good designs, grows slowly from zero. Can be stopped.	Created instantly, then usually doesn't grow.
Predictive methods	Well developed. Combined with fatigue tests give quite good idea of fatigue life	Poor prediction due to lack of appropriate statistical data
Inspection interval	Quite certain: should be long enough to detect growing crack	Uncertain: no deterministic criteria to follow

- Developed a Probabilistic Method for Determining the Inspection Intervals for Aircraft Composite Structures.
- Developed Computing Tools and Algorithms for the Probabilistic Analysis.
- Established In-service Damage Database from FAA SDR and Other Sources.
- Demonstrated the Developed Method on Existing Structural Components.

Various Failure Modes

Strength/Stiffness vs. Temperature

Moisture Content vs. Time

Residual Strength/Stiffness vs. Damage Size & Damage Type

Probability of Detection vs. Damage Size & Damage Type

Maximum Load vs. Time of Damage Existence

Damage Size & Damage Type Spectra

Structural Temperature Spectra

Strength/Stiffness Degradation due to Environmental Exposure

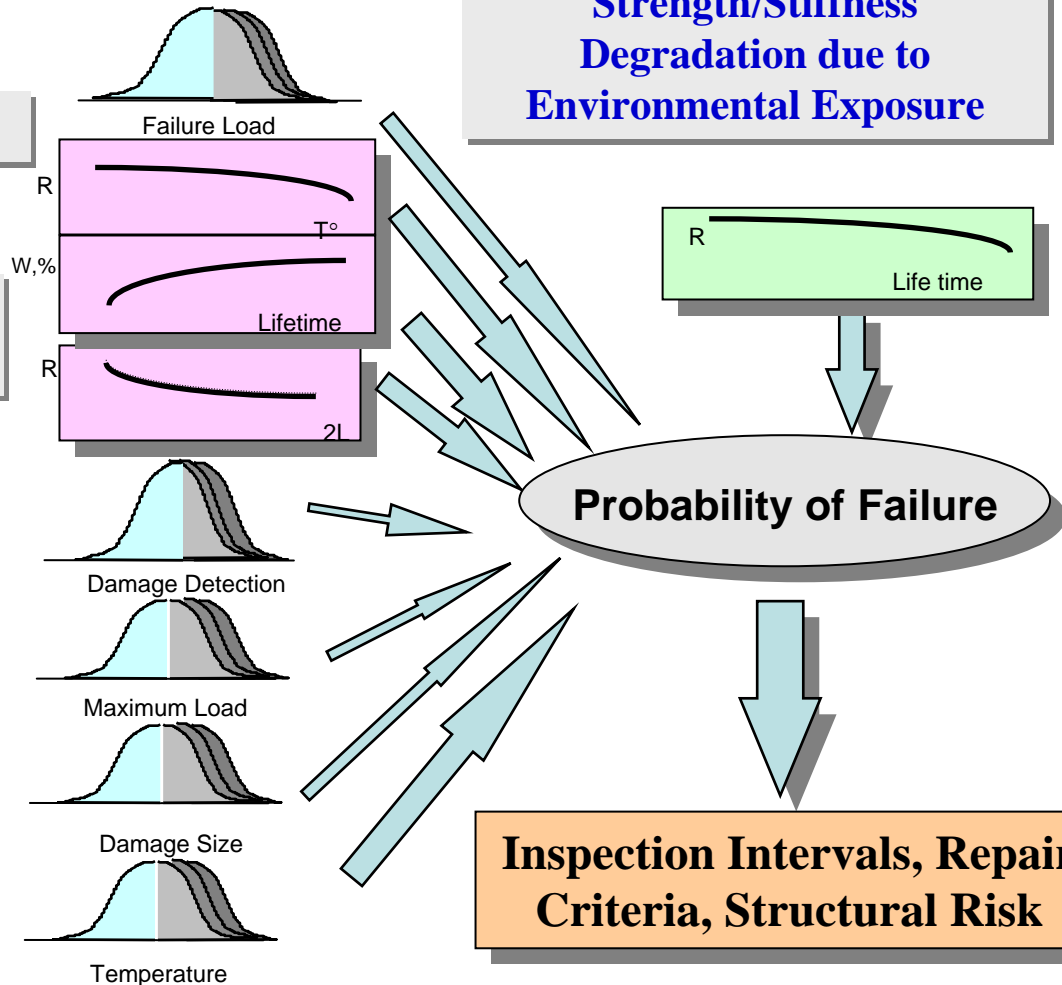

The Probabilistic Model

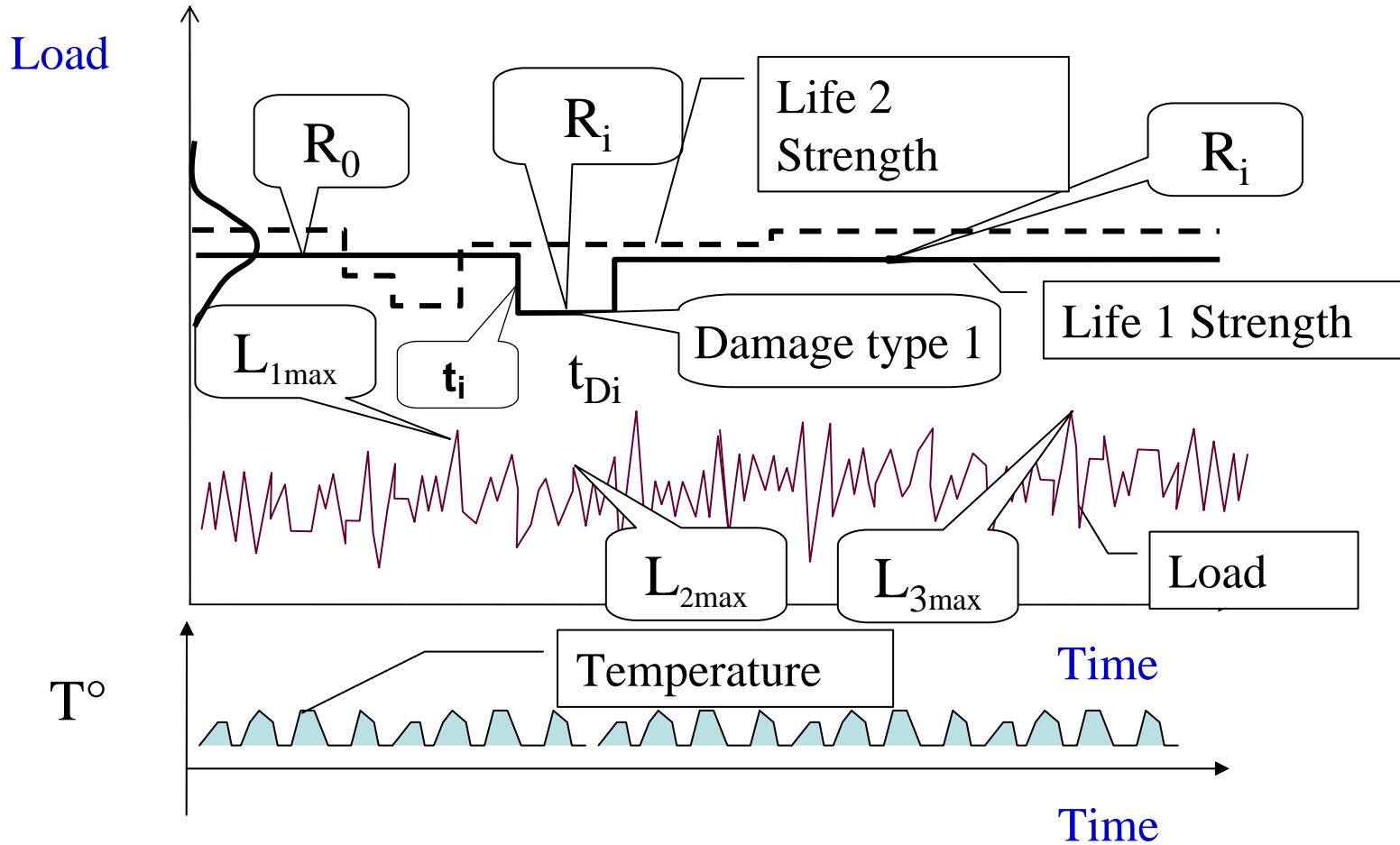

Program Capabilities: Various Failure Modes

- “Static” failure: load exceeds the strength of damaged structures
- Deformation exceeds acceptable level
- Flutter: airspeed exceeds the flutter speed of damaged or repaired structure*
- High amplitude limit cycle oscillations: the acceptable level of vibrations is exceeded*

**See the FAA Grant “Combined Local-Global Variability and Uncertainty in the Aeroservoelasticity of Composite Aircraft”*

Program Capabilities:

Minimum Risk Maintenance Planning

Microsoft Excel - V22_SDM_2007.xls

File Edit View Insert Format Tools Chart Window Help Adobe PDF

Type a question for help

Value (X) axis

1
 2 **Directory to Run Simulation** C:\projects\MCSim_V22 Find Data Directory

3

4 **Full M-C P.O.F. = 0.04807**

5 **Integration P.O.F. = 1.0158544E-04**

6

7 Costs of

8 Aircraft 50000000.0000

9 Failure 2.000000

10 Field Inspection 0.000004

11 Facility Inspection 0.000120

12 Repair 1 0.000020

13 Repair 2 0.000060

14 Temporary Repair 0.000006

15 Delay 0.0036

16

17 1st for both 1.45E-02 1st Insp 0.3677 2nd Insp 2.5761

18 2nd for both 4.81E-02 6.19E-01 1.3598

19

20 2nd for both 1st for both 1 dent 2 Del

21 POF a1 POF a2 POF a3

22 100 1.077E-03 0.01651 0.1285 0.27128 1.26E-03 0.1

23 50 2.030E-03 0.01242 0.1246 0.25752 2.12E-03 0.1

24

25

26

27

28

29

30

31

32

33

34

35

36

37

38

39

40

Check Data Consistency

Run Integration

Regression Sensitivity

Wu's Sensitivity

Write Input Files

Make8Points

Maintenance Planning Support: V2.2 Data Format

Diverted flight from: Jenkins, C

Probability of Failure

1.0E+00

100.0 1000.0 10000.0

1.0E-01

1.0E-02

1.0E-03

Inspection interval, Flights

Utility

0.01800

0.01700

0.01600

0.01500

0.01400

0.01300

0.01200

0.01100

0.01000

0.00900

0.00800

0 100 200 300 400 500 600

Inspection Interval, Flights

a1

a3

a4

0.3387 1.46E-02 0.02990

0.0216 4.81E-02 0.09651

0.8246 0.1300 0.26024

Pro1000 / Conversion / Command / n0.dat / n1.dat / n2.dat / n3.dat / n4.dat / n5.dat / n6.dat / n7.dat / n8.dat / n9.dat

Ready

Start AIAA_SAMPE Microsoft PowerPoint - [J... Microsoft Excel - V22_...

8:19 PM

SDR: External Damage Map

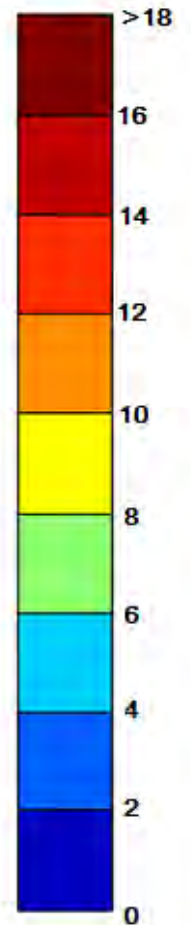
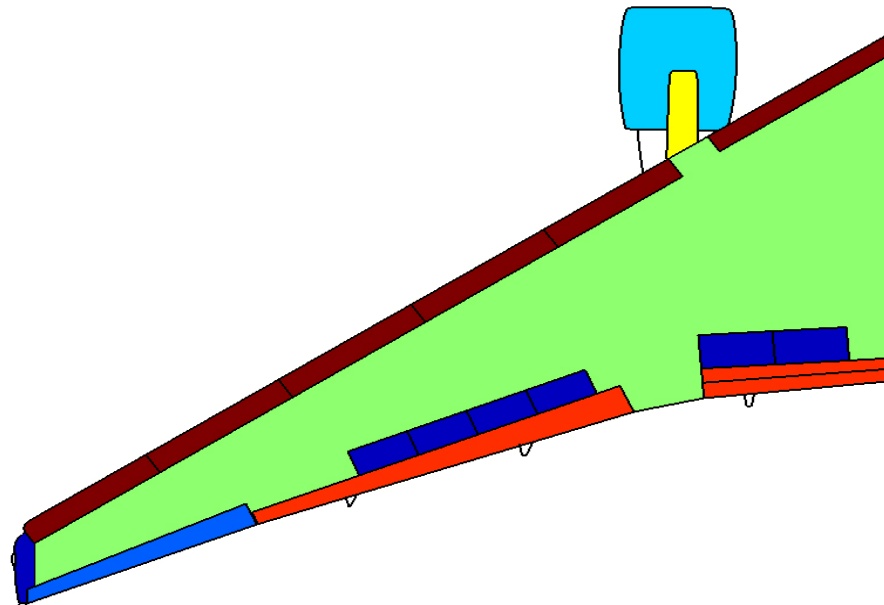
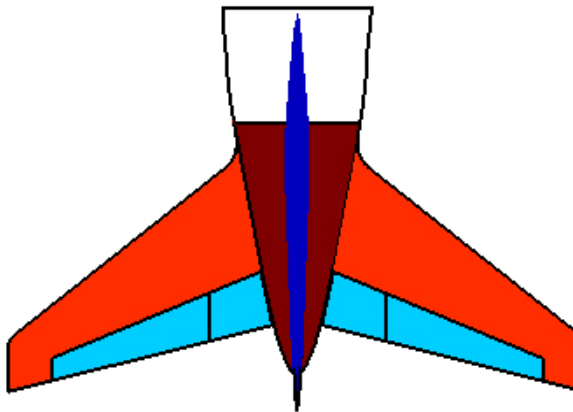
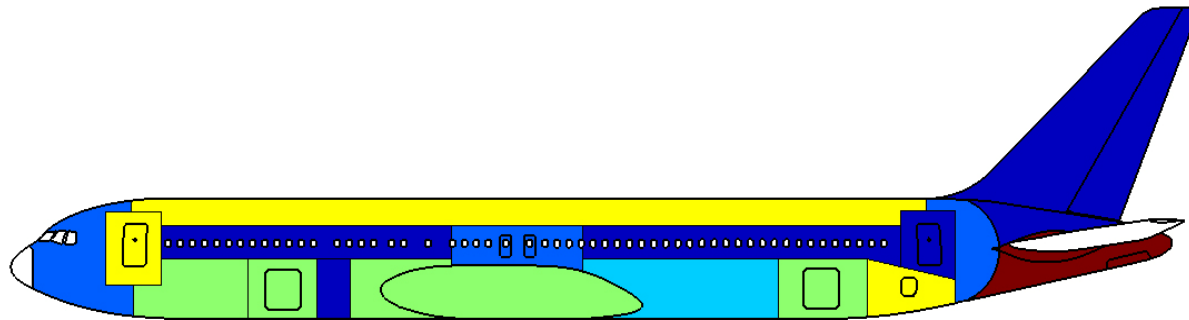

Family of Experiments (Inspection selection) $E = \{e\}$

- e_1, e_2 = Various Combinations of Inspection Methods and Intervals
- e_3 = No Inspections

Space of Experiment Outcomes (Inspection results) $Z = \{z\}$

- z_1, z_2, \dots = Various Damages Observed

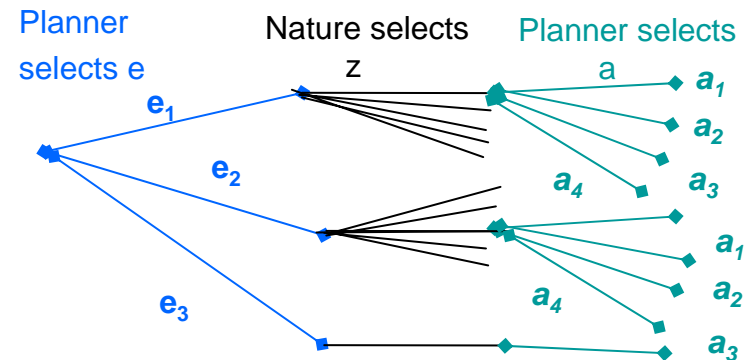
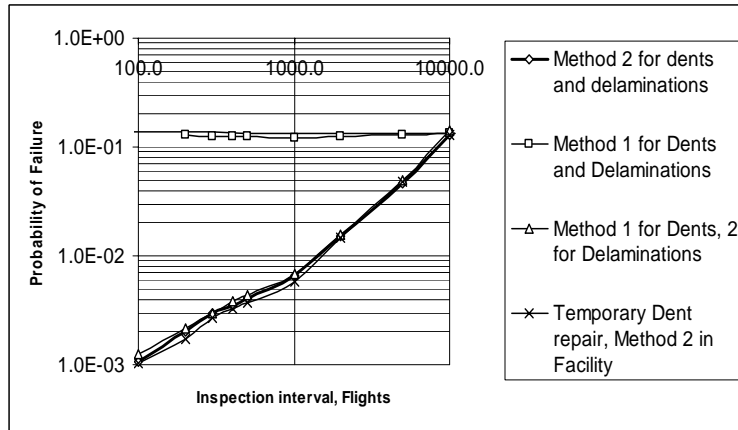

Figure Decision-making tree for inspections

Space of Acts (Repair selection) $A = \{a\}$, e.g.

- a_1 = Method 1 for Field and Facility repair of all damages
- a_2 = Method 2 for Field and Facility repair of all damages
- a_3 = Method 1 for holes/dents, Method 2 for delaminations
- a_4 = Temporary repair for holes/dents, detected in pre-flight Inspections, Method 2 for holes/dents, delaminations in Facility



Utility Equations:

$$a_1: u(e, z, a_1, \theta) = 2P_f + 0.0012N_m + (0.0036 + 6 \cdot 10^{-5})N_{rep1} + 6 \cdot 10^{-5}N_{rep2}$$

$$a_2: u(e, z, a_1, \theta) = 2P_f + 0.0012N_m + (0.0036 + 2 \cdot 10^{-5})N_{rep1} + 2 \cdot 10^{-5}N_{rep2}$$

$$a_3: u(e, z, a_1, \theta) = 2P_f + 0.0012N_m + (0.0036 + 2 \cdot 10^{-5})N_{rep1} + 6 \cdot 10^{-5}N_{rep2}$$

$$a_4: u(e, z, a_1, \theta) = 2P_f + 0.0012N_m + 2 \cdot 10^{-6}N_{rep1} + 6 \cdot 10^{-5}N_{rep2}$$

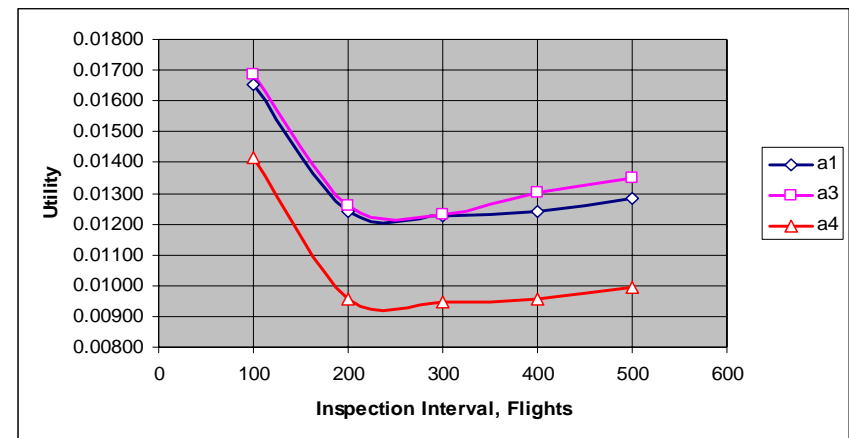
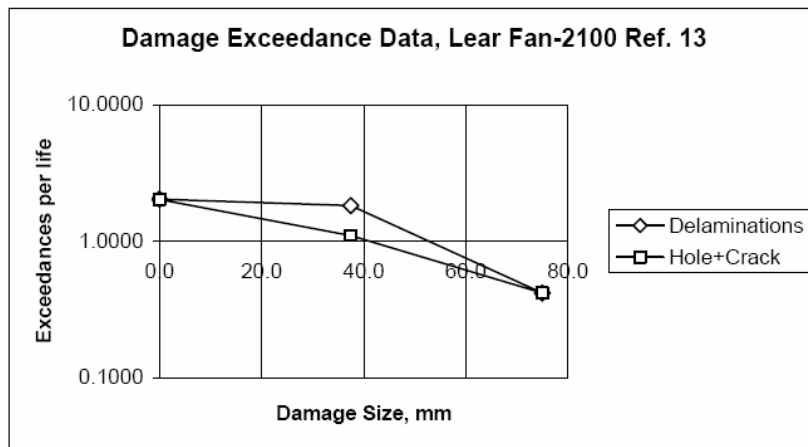

For large damage that will be repaired within a few flights: key factor is repair quality

Current State:

- Fixed set of Random Variables
- 1D Failure Criteria:
 - Stress > Allowable
 - Load > Strength
 - Temperature > Allowable
 - Disbond Area > Allowable
 - Airspeed > Flutter Speed
- Post-primary-failure 1D Criteria
- Simple Equation-Style Maintenance-Risk Cost Model

Demanded State:

- User-defined Set of Random Variables

Damage-dependent Variables

Damage-independent Variables

- Complex User-defined Structural Model

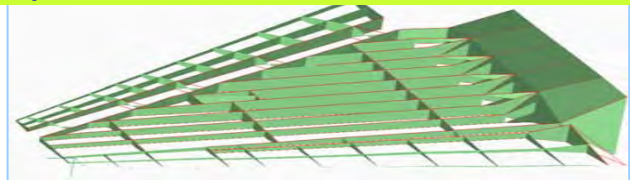

- Complex User-defined Failure Criteria

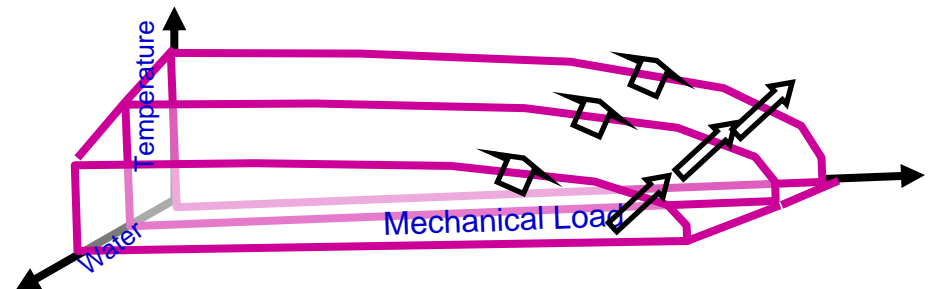

A Potential Tool: Integration with FEA Models

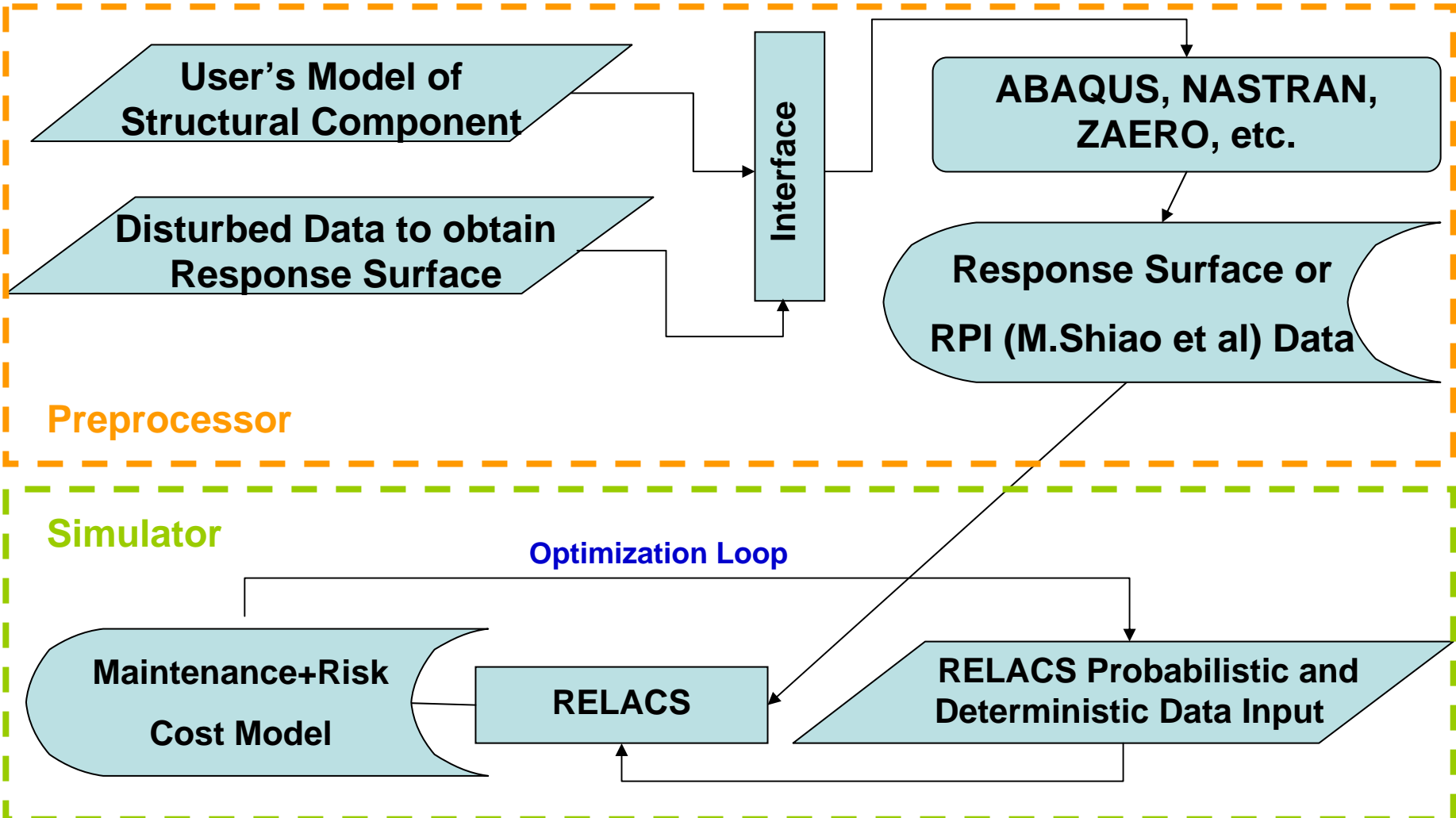

Damage Growth Consideration

A Preliminary Study

- A generic composite fuselage sub-section (24-ply isotropic) with hat stringer (8-ply isotropic) reinforcement is modeled in ABAQUS ($r = 115''$; one frame bay is considered)
- Debonding of various sizes are implanted at the center of the stringer, on both legs of the hat stringer
- Skin-stringer debonding under shear is considered
- Frames spacing at 24'' (debonding cannot penetrate frame locations)

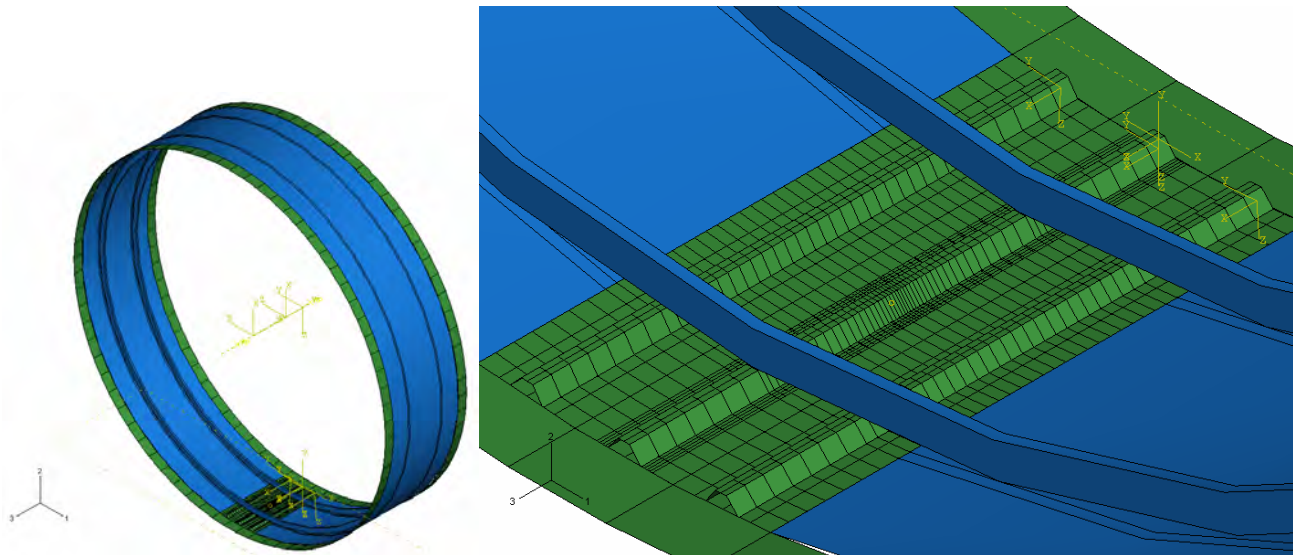

Initial flaw = 0.96”

- Initial debonding means the 30 nodes at the center of the stringer are not connected; the remaining 360 nodes are bonded.
- Torsion load on fuselage is ramped from 0 in-lb to 3×10^8 in-lb.
- Nodes released represent the extension of debonding somewhere along the crack front.

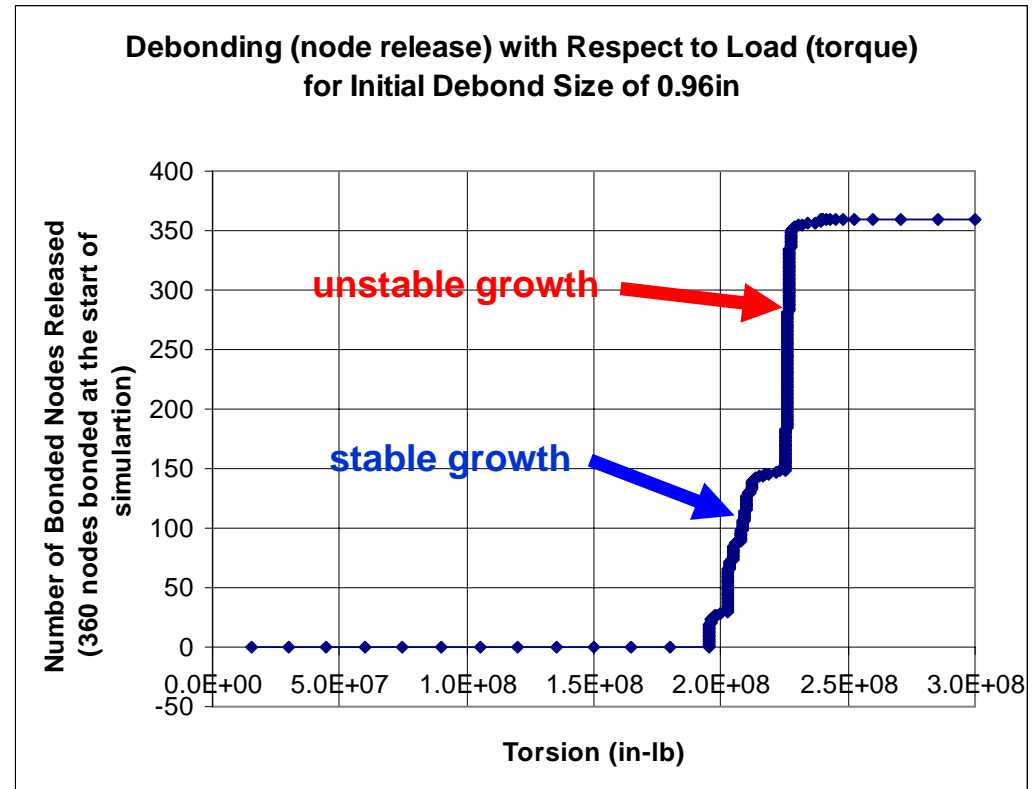

[click for movie](#)

Damage Growth Consideration

Results for Various Initial Damage Sizes

- Ultimate load capability reduction due to completed debonding of one stringer is minimal.
- There is a significant difference between stable and unstable growth load levels.
- Sub-structure is considered “completely failed” when unstable growth load level is reached and the stringer completely separates from the skin for the entire frame bay.

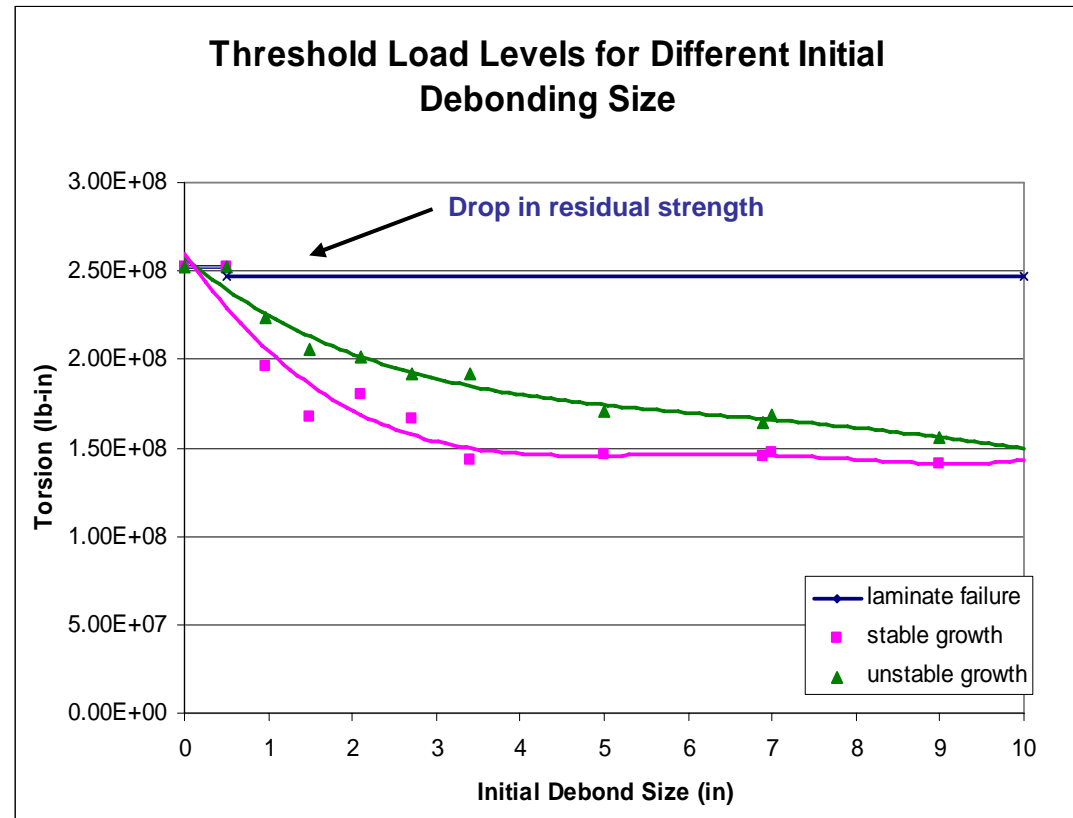

Practical Applications of the Present Code, “RELACS”

- Currently, the reliability analysis allows continuously adjustable inspection intervals, this is not realistic in the real world as many “maintenance tasks” are grouped together and performed in “maintenance checks (A,B,C,D checks)”.
- Inspection scheduling and maintenance are influenced by other technical factors: availability of certified technician and equipments, environmental and operational limitations (deferred repairs), etc.
- Maintenance planning is also influenced by costs, reliability and safety, damage statistics from service history, etc.
- Collaborations with specialists in the life-cycle management area could help define many variables and guide the development of the software towards industrial applications.

Work Accomplished:

- Developed a method for determining POF and the inspection intervals.
- Developed a preliminary computer program for calculating POF and the inspection intervals.
- Mined statistical data on damage and other probabilistic parameters.

Work in Progress:

- Enhance the current method for POF and the inspection intervals.
- Complete a user friendly computer code and a user's manual for the probabilistic design of damage-tolerant composite structures.



THANK YOU

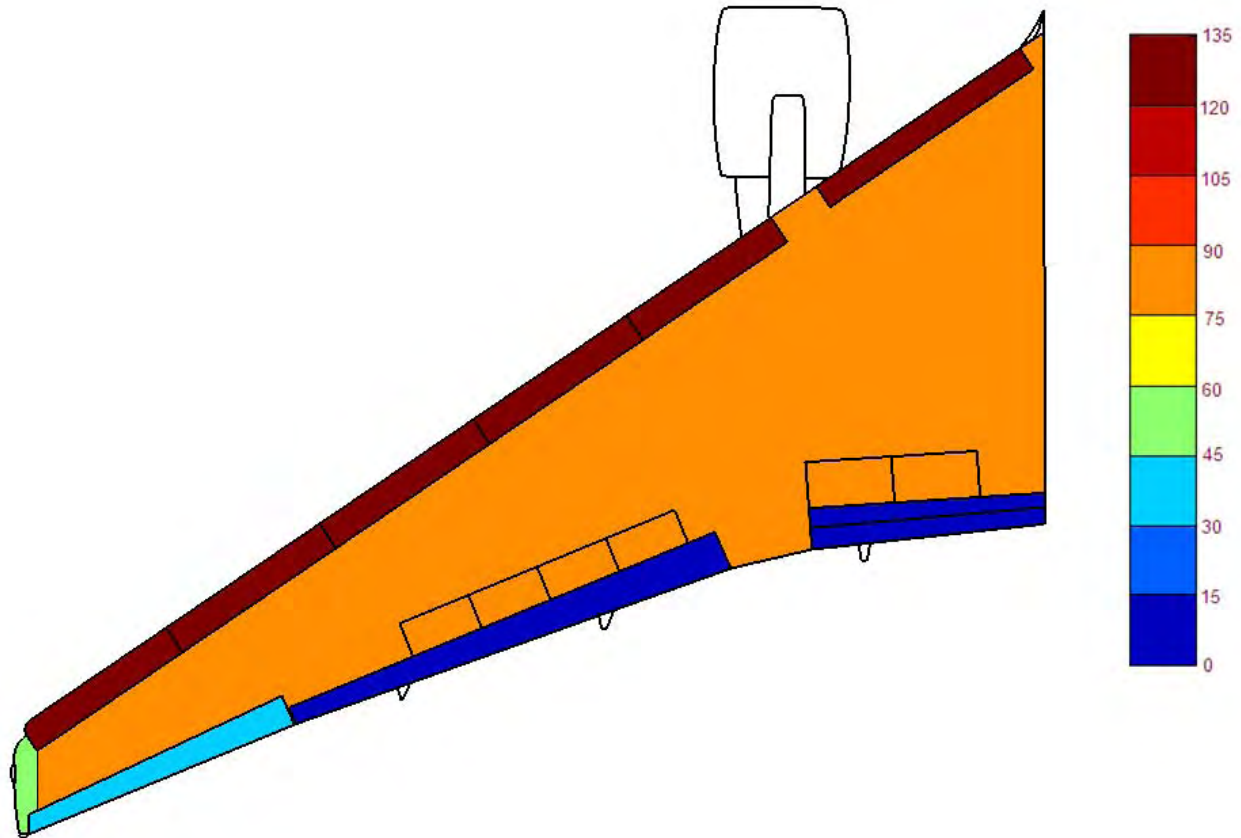

- Aluminum-Honeycomb sandwich delamination is a reoccurring problem – slats, flaps and stabilizers on 767s shows large number of delamination occurrences.
- Nearly all dents, holes and gouges are on the lower fuselage and are caused by ground activities, e.g. trucks and operation staff.
- Majority of the damages on the upper fuselage are caused by lightning strikes.
- Large number of cracks and fatigue damages occurred near the horizontal stabilizer cutout region.
- Although the wings have very large areas, relatively few major damages are recorded.